

This booklet sets out to explain the fundamentals of sound intensity measurement. Both theory and applications will be covered. Although the booklet is intended as a basic introduction, some knowledge of sound pressure measurement is assumed. If you are unfamiliar with this subject, you may wish to consult our companion booklet "Measuring Sound".

	See page		See page
Introduction	2	Spatial Averaging	15
Sound Pressure and Sound Power	3	What about Background Noise?	16
What is Sound Intensity?	4	Noise Source Ranking	17
Why Measure Sound Intensity?	5	Intensity Mapping	18-19
Sound Fields	6-7	Applications in Building Acoustics	20
Pressure and Particle Velocity	8	Instrumentation	21
How is Sound Intensity Measured?	9-10	Making Measurements	22-23
The Sound Intensity Probe	11	Further Applications and Advanced Topics	24-25
Reference Levels	12	Case Studies	26-29
Some Examples	13	Appendix: Measurement Limitations	30-33
Using Sound Intensity to Determine Sound Power	14	Further Reading	34-36

Introduction

Acoustic measurements and acoustic theory have not always progressed side by side. The publication of Lord Rayleigh's influential work, "The Theory of Sound", laid the foundations of modern acoustics. The quantity *sound intensity* was fundamental to this theory. But a full hundred years were to elapse before the emergence of a thoroughly practical method of measuring sound intensity.

Developments in electronics at the beginning of this century slowly brought measurement into step with theory. These included the triode amplifier invented by L. de Forest in 1906, and E. C. Wente's first condenser microphone, designed in 1915. A device patented by H. F. Olson in 1932 measured sound intensity but it apparently worked only under idealized conditions. Despite several other attempts no commercial device was produced.

The commercial era did not begin until 1977, when digital signal processing techniques were applied to the theory independently by F. J. Fahy and J. Y. Chung. And with advances in microphone design, reliable measurement at last became possible with two closely spaced microphones.

In the short space of time since this breakthrough the method has become established. While giving theoretical acousticians the chance to measure and visualize quantities that previously had been confined to their mathematical textbooks, it is also proving invaluable in many varied applications to the noise control engineer.

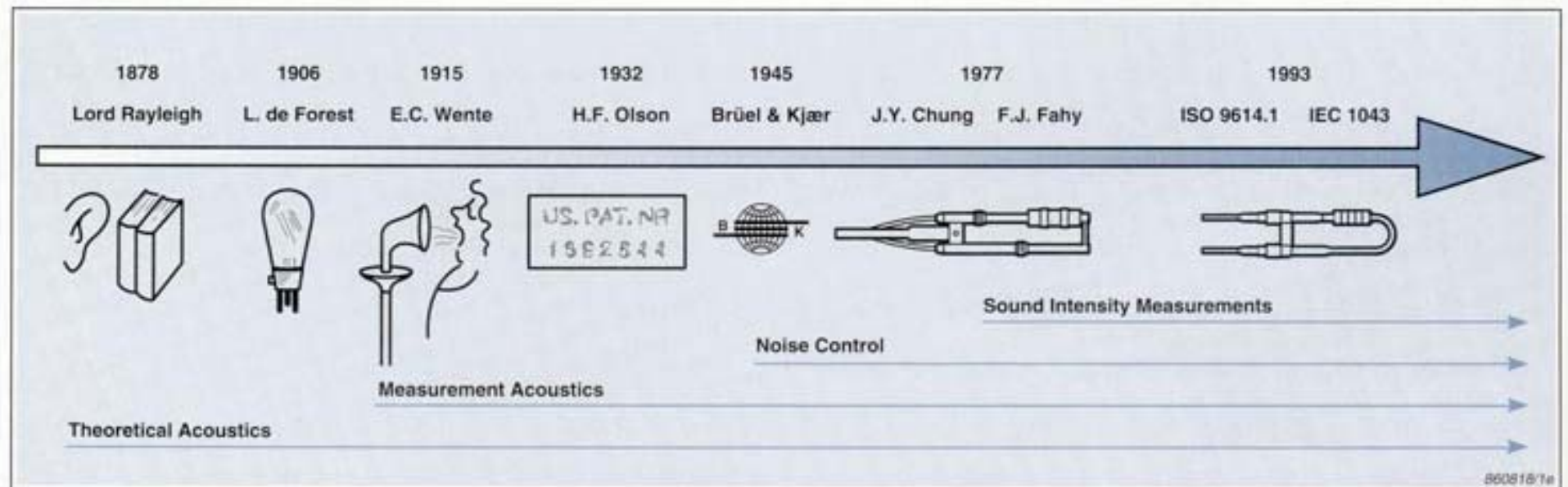

Sound Pressure and Sound Power

A sound source radiates power and this results in a sound pressure. Sound power is the cause. Sound pressure is the effect. Consider the following analogy. An electric heater radiates heat into a room and temperature is the effect. Temperature is also the physical quantity that makes us feel hot or cold. The temperature in the room is obviously dependent on the room itself, the insulation, and whether other sources of heat are present. But for the same electrical power input, the heater radiates the same power, practically independent of the environment. The relationship between sound power and sound pressure is similar. What we hear is sound pressure but it is caused by the sound power emitted from the source.

Too high a sound pressure may cause hearing damage. So when trying to quantify human response to sound, such as noise annoyance or the risk of hearing loss, pressure is the obvious quantity to measure. It is also relatively easy to measure: The pressure variations on the eardrum we perceive as sound are the same pressure variations which are detected on the diaphragm of a condenser microphone.

The sound pressure that we hear, or measure with a microphone is dependent on the distance from the source and the acoustic environment (or *sound field*) in which sound waves are present. This in turn depends on the size of the room and the sound absorption of the surfaces. So by measuring sound pressure we cannot necessarily quantify how much noise a machine makes. We have to find the sound power because this quantity is more or less independent of the environment and is the unique descriptor of the noisiness of a sound source.

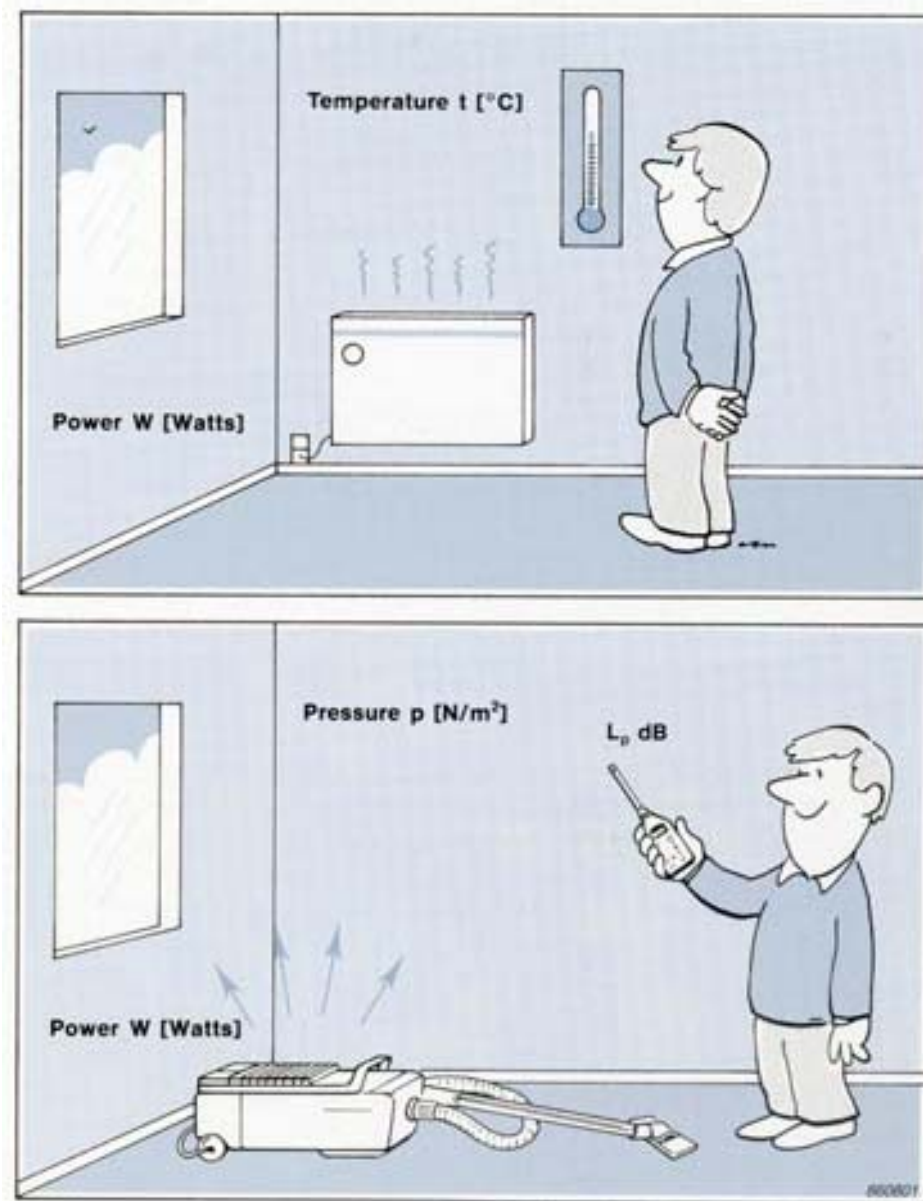

What is Sound Intensity?

Any piece of machinery that vibrates radiates acoustical energy. *Sound power* is the rate at which energy is radiated [energy per unit time]. *Sound intensity* describes the rate of energy flow through a unit area. In the SI system of units the unit area is 1 m^2 . And hence the units for sound intensity are Watts per square metre.

Sound intensity also gives a measure of direction as there will be energy flow in some directions but not in others. Therefore sound intensity is a *vector* quantity as it has both magnitude and direction. On the other hand pressure is a *scalar* quantity as it has magnitude only. Usually we measure the intensity in a direction *normal* (at 90°) to a specified unit area through which the sound energy is flowing.

We also need to state that sound intensity is the time-averaged rate of energy flow per unit area. In some cases energy may be travelling back and forth. This will not be measured; if there is no net energy flow there will be no net intensity.

In the diagram opposite the sound source is radiating energy. All this energy must pass through an area enclosing the source. Since intensity is the power per area, we can easily measure the normal *spatial-averaged* intensity over an area which encloses the source and then multiply it by the area to find the sound power. Note that intensity (and pressure) follows the inverse square law for free field propagation. This can be seen in the diagram, at a distance $2r$ from the source the area enclosing the source is 4 times as large as the area at a distance r . Yet the power radiated must be the same whatever the distance and consequently the intensity, the power per area, must decrease.

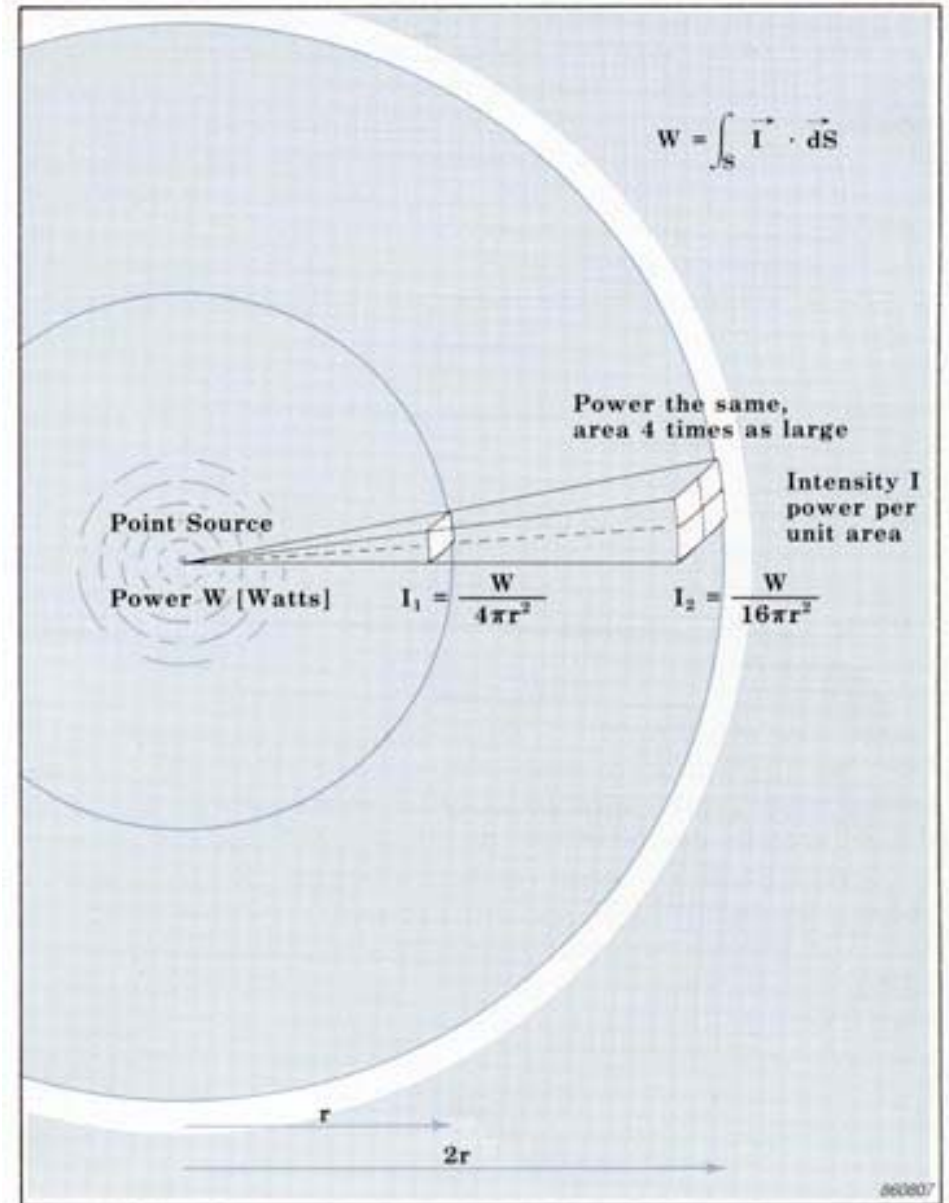

Why Measure Sound Intensity?

On the factory floor we can make sound pressure measurements and find out if the workers risk hearing damage. But once we have found this, we may well want to reduce the noise. To do this, we need to know how much noise is being radiated and by what machine. We therefore need to know the sound power of the individual machines and rank them in order of highest sound power. Once we have located the machine making most noise we may want to reduce the noise by locating the individual components radiating noise.

We can do all this with intensity measurements. Previously we could only measure pressure which is dependent on the sound field. Sound power can be related to sound pressure only under carefully controlled conditions where special assumptions are made about the sound field. Specially constructed rooms such as anechoic or reverberant chambers fulfil these requirements. Traditionally, to measure sound power, the noise source had to be placed in these rooms.

Sound intensity, however, can be measured in any sound field. No assumptions need to be made. This property allows all the measurements to be done directly in situ. And measurements on individual machines or individual components can be made even when all the others are radiating noise, because steady background noise makes no contribution to the sound power determined when measuring intensity.

Because sound intensity gives a measure of direction as well as magnitude it is also very useful when locating sources of sound. Therefore the radiation patterns of complex vibrating machinery can be studied in situ.

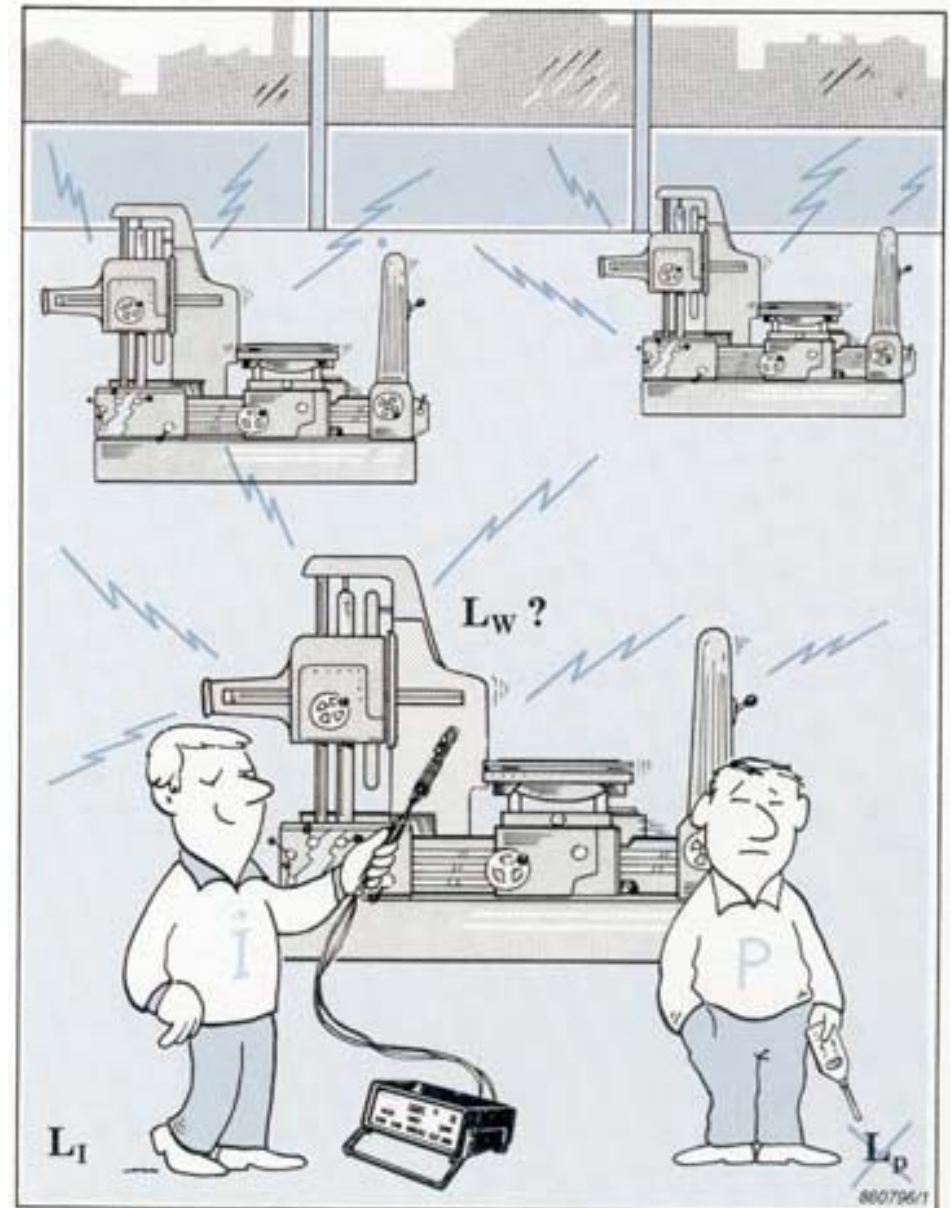

Sound Fields

A sound field is a region where there is sound. It is classified according to the manner and the environment in which the sound waves travel. Some examples will now be described and the relationship between pressure and intensity discussed. This relationship is precisely known **only** in the first two special cases described below.

The Free Field

This term describes sound propagation in idealized free space where there are no reflections. These conditions hold in the open air (sufficiently far enough away from the ground) or in an anechoic room where all the sound striking the walls is absorbed. Free field propagation is characterized by a 6 dB drop in sound pressure level and intensity level (in the direction of sound propagation) each time the distance from the source is doubled. This is simply a statement of the inverse square law. The relationship between sound pressure and sound intensity (magnitude only) is also known. It gives one way of finding sound power which is described in the International Standard ISO 3745.

The Diffuse Field

In a diffuse field, sound is reflected so many times that it travels in all directions with equal magnitude and probability. This field is approximated in a reverberant room. Although the net intensity is zero, there is a theoretical relationship which relates the pressure in the room to the *one-sided Intensity*, I_x . This is the intensity in one direction, ignoring the equal and opposite component. One-sided intensity cannot be measured by a sound intensity analyzer but it is nevertheless a useful quantity: By measuring pressure we can use the relationship between pressure and one-sided intensity to find the sound power. This is described in ISO 3741.

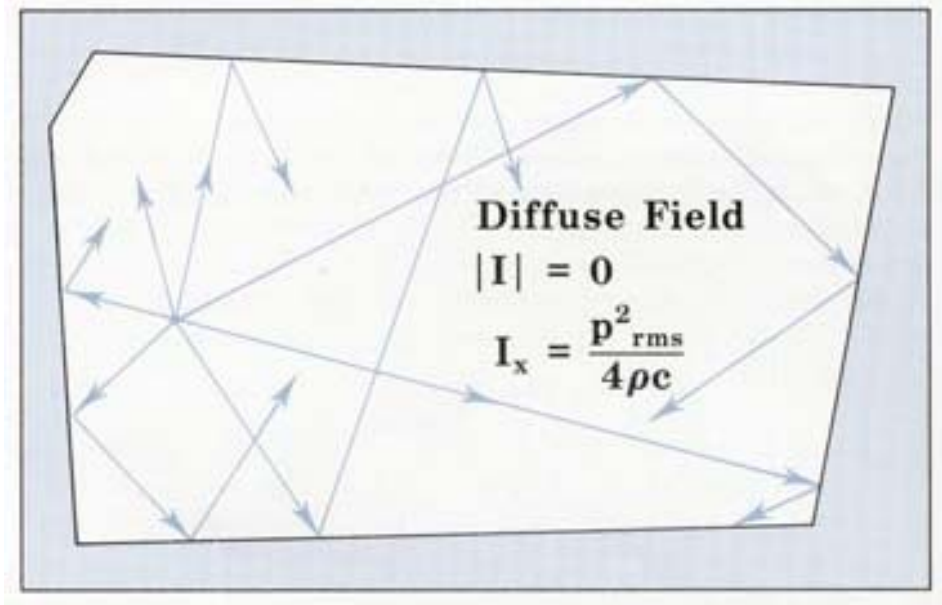
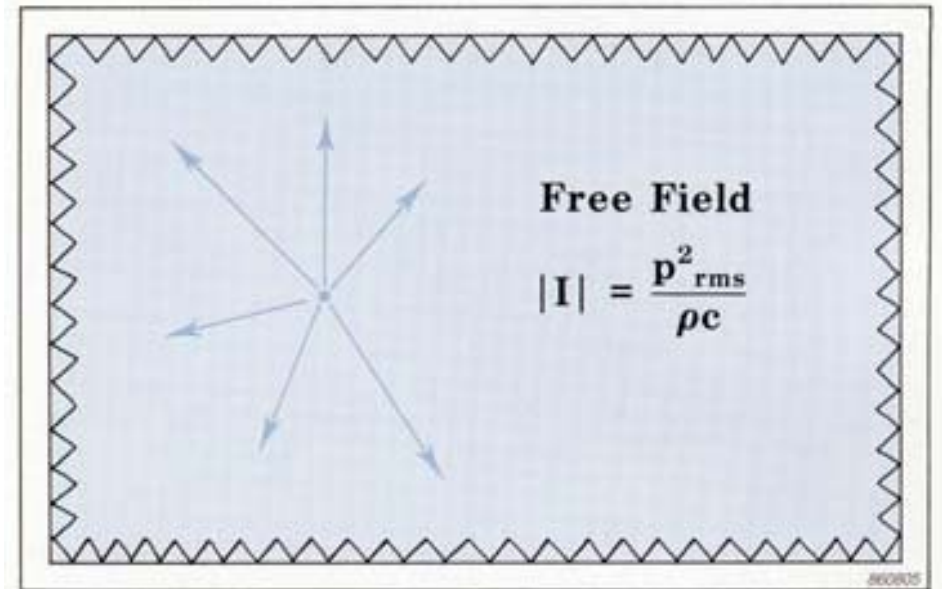

Active and Reactive Sound Fields

Sound propagation involves energy flow but there can still be a sound pressure even when there is no propagation. An *active* field is one where there is energy flow. In a pure *reactive* field, there is no energy flow. At any instant energy may be travelling outward, but it will always be returned at a later instant. The energy is stored as if in a spring. Hence the net intensity is zero. In general a sound field will have both active and reactive components. Pressure measurements for sound power in fields which are not well-defined can be unreliable, since the reactive part is unrelated to the power radiated. We can, however, measure sound intensity. Since sound intensity describes energy *flow*, there will be no contribution from the reactive component of the field. Two examples of reactive fields follow.

Standing Waves in a Pipe

Consider a piston exciting the air at one end of a tube. At the other end there is a termination which causes the sound waves to be reflected. The combination of the forward-travelling and reflected waves produces patterns of pressure maxima and minima which occur at fixed distances along the tube. If the termination is completely rigid all the energy is reflected and the net intensity is zero. With an absorptive termination some intensity will be measured. Standing waves are also present in rooms at low frequencies.

The Near Field of a Source

Very close to a source, the air acts as a mass-spring system which stores the energy. The energy circulates without propagating and the region in which it circulates is called the near field. Only sound intensity measurements for sound power determination can be made here. And because it is possible to get close to the source, the signal-to-noise ratio is improved.

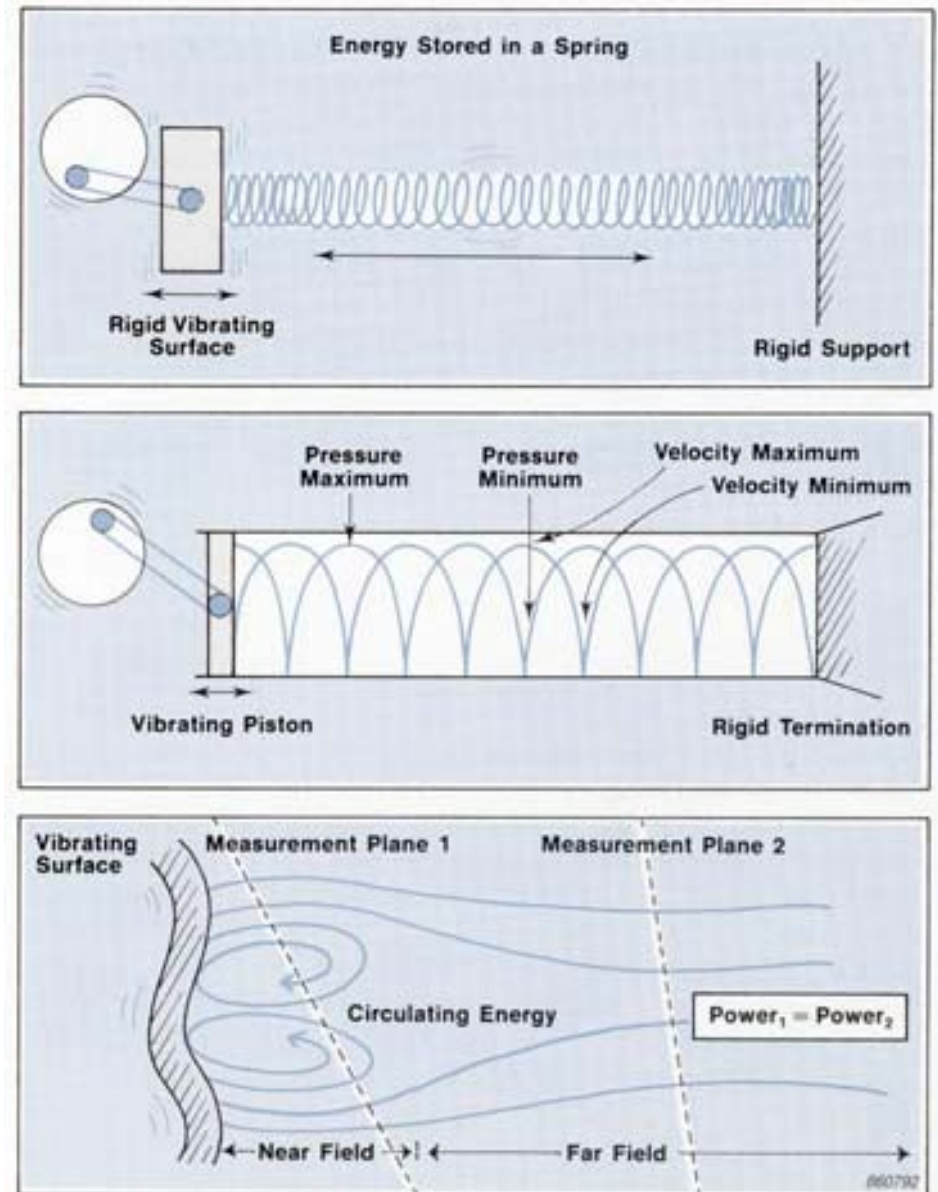

Pressure and Particle Velocity

When a particle of air is displaced from its mean position there is a temporary increase in pressure. The pressure increase acts in two ways: to restore the particle to its original position, and to pass on the disturbance to the next particle. The cycle of pressure increases (compressions) and decreases (rarefactions) propagates through the medium as a sound wave. There are two important parameters in this process: the pressure (the local increases and decreases with respect to the ambient) and the velocity of the particles of air which oscillate about a fixed position. Sound intensity is the product of particle velocity and pressure. And, as can be seen from the transformation below, it is equivalent to the power per unit area definition given earlier.

$$\begin{aligned} \text{Intensity} &= \text{Pressure} \times \text{Particle Velocity} \\ &= \frac{\text{Force}}{\text{Area}} \times \frac{\text{Distance}}{\text{Time}} = \frac{\text{Energy}}{\text{Area} \times \text{Time}} = \frac{\text{Power}}{\text{Area}} \end{aligned}$$

In an active field, pressure and particle velocity vary simultaneously. A peak in the pressure signal occurs at the same time as a peak in the particle velocity signal. They are therefore said to be *in phase* and the product of the two signals gives a net intensity. In a reactive field the pressure and particle velocity are 90° *out of phase*. One is shifted a quarter of a wavelength with respect to the other. Multiplying the two signals together gives an *instantaneous* intensity signal varying sinusoidally about zero. Therefore the *time-averaged* intensity is zero.

In a diffuse field the pressure and particle velocity phase vary at random and so the net intensity is zero.

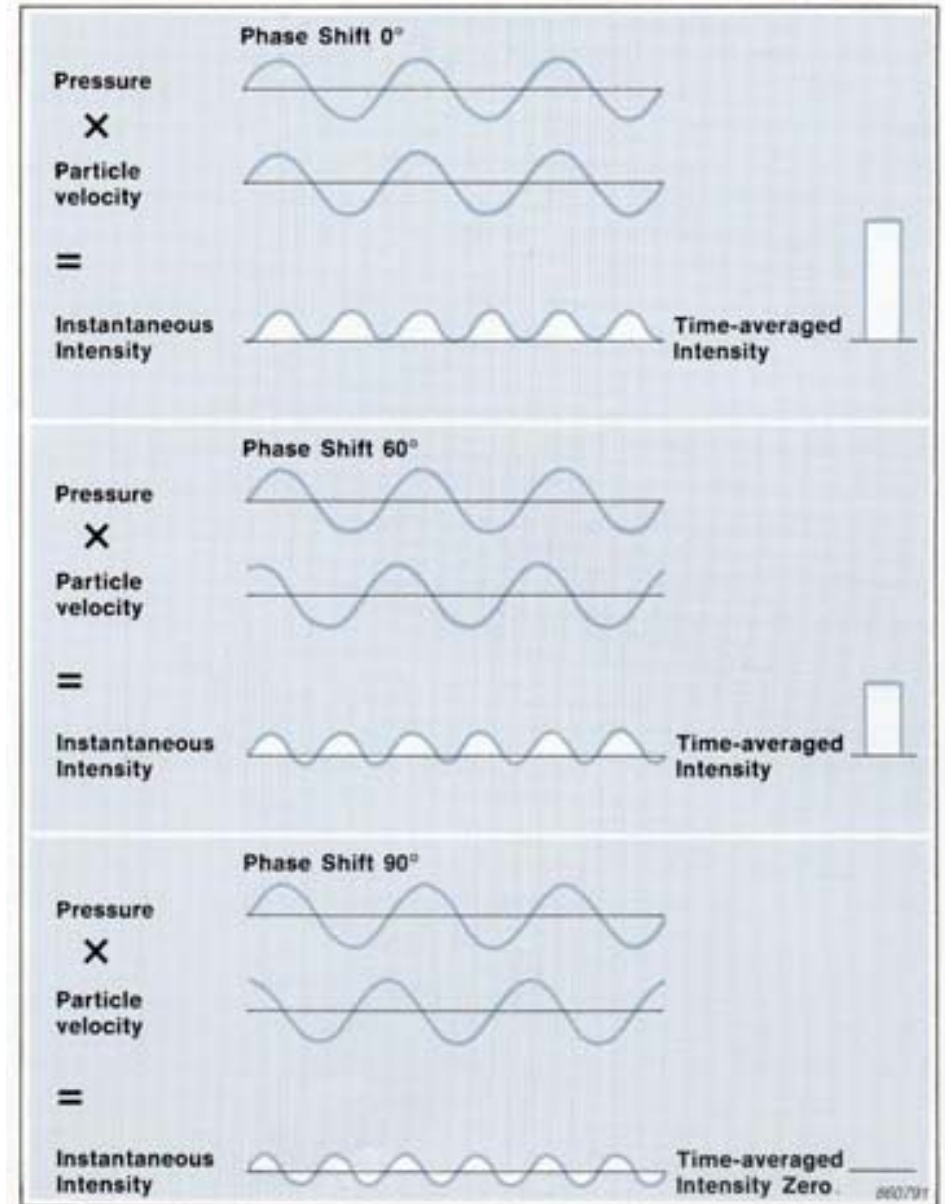

How is Sound Intensity Measured?

The Euler Equation: Finding the Particle Velocity

Sound intensity is the time-averaged product of the pressure and particle velocity. A single microphone can measure pressure — this is not a problem. But measuring particle velocity is not as simple. The particle velocity, however, can be related to the *pressure gradient* (the rate at which the instantaneous pressure changes with distance) with the linearized Euler equation. With this equation, it is possible to measure this pressure gradient with two closely spaced microphones and relate it to particle velocity.

Euler's equation is essentially Newton's second law applied to a fluid. Newton's Second Law relates the acceleration given to a mass to the force acting on it. If we know the force and the mass we can find the acceleration and then integrate it with respect to time to find the velocity.

With Euler's equation it is the pressure *gradient* that accelerates a fluid of density ρ . With knowledge of the pressure gradient and the density of the fluid, the particle acceleration can be calculated. Integrating the acceleration signal then gives the particle velocity.



Sir Isaac Newton

$$\mathbf{F} = m\mathbf{a}$$
$$\mathbf{a} = \frac{\mathbf{F}}{m}$$
$$\mathbf{v} = \int \frac{\mathbf{F}}{m} dt$$

Leonhard Euler

$$\mathbf{a} = -\frac{1}{\rho} \text{grad } p$$

In one direction

$$\frac{\partial u}{\partial t} = -\frac{1}{\rho} \frac{\partial p}{\partial r}$$
$$u = -\int \frac{1}{\rho} \frac{\partial p}{\partial r} dt$$

The Finite Difference Approximation

The pressure gradient is a continuous function, that is, a smoothly changing curve. With two closely spaced microphones it is possible to obtain a straight line approximation to the pressure gradient by taking the difference in pressure and dividing by the distance between them. This is called a finite difference approximation. It can be thought of as an attempt to draw the tangent of a circle by drawing a straight line between two points on the circumference.

The Intensity Calculation

The pressure gradient signal must now be integrated to give the particle velocity. The estimate of particle velocity is made at a position in the acoustic centre of the probe, between the two microphones. The pressure is also approximated at this point by taking the average pressure of the two microphones. The pressure and particle velocity signals are then multiplied together and time averaging gives the intensity.

A sound intensity analyzing system consists of a probe and an analyzer. The probe simply measures the pressure at the two microphones. The analyzer does the integration and calculations necessary to find the sound intensity. These equations are not new. What is new is the use of modern signal processing techniques to implement the equation. This can be done in two ways: by directly using integrators and filters (analogue or digital) to implement the equation step by step, or by using an FFT analyzer. The latter relates the intensity to the imaginary part of the cross spectrum (a mathematical term) of two microphone signals. The formulations are equivalent; both give the sound intensity.

Time Domain Formulation

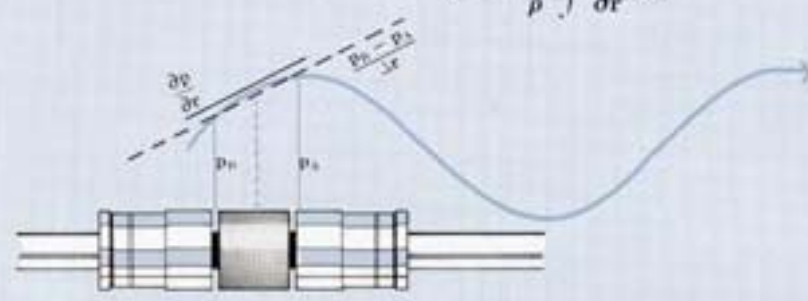

The Finite Difference Approximation

Average pressure

From Euler

$$u = -\frac{1}{\rho} \int \frac{\partial p}{\partial r} dt$$

$$u = -\frac{1}{\rho} \int \frac{p_B - p_A}{\Delta r} dt$$

Average pressure

$$p = \frac{p_A + p_B}{2}$$

$$I = \overline{p \cdot u}$$

$$I = -\frac{p_A + p_B}{2\rho\Delta r} \int (p_B - p_A) dt$$

Frequency Domain Formulation for FFT Analyzers

$$I = -\frac{1}{\rho\omega\Delta r} \text{Im } G_{AB}$$

ω is the angular frequency

$\text{Im } G_{AB}$ is the imaginary part of the cross spectrum

060794

The Sound Intensity Probe

The Brüel&Kjær probe has two microphones mounted face to face with a solid spacer in between. This arrangement has been found to have better frequency response and directivity characteristics than side-by-side, back-to-back or face-to-face *without* solid spacer arrangements. Three solid spacers define the effective microphone separation to 6, 12 or 50 mm. The choice of spacer depends on the frequency range to be covered. Half-inch microphones are used for lower frequencies. But smaller quarter-inch microphones are used at high frequencies to reduce interference effects.

Directivity Characteristics

The directivity characteristic for the sound intensity analyzing system looks (two-dimensionally) like a figure-of-eight pattern — known as a cosine characteristic. This is due to the probe and the calculation within the analyzer.

Since pressure is a scalar quantity, a pressure transducer should have an equal response, no matter what the direction of sound incidence (that is, we need an omnidirectional characteristic). In contrast, sound intensity is a vector quantity. With a two-microphone probe, we do not measure the vector however; we measure the component in one direction, along the probe axis. The full vector is made up of three mutually perpendicular components (at 90° to each other) — one for each coordinate direction.

For sound incident at 90° to the axis there is no component along the probe's axis, as there will be no difference in the pressure signals. Hence there will be zero particle velocity and zero intensity. For sound incident at an arbitrary angle θ to the axis the intensity component along the axis will be reduced by the factor $\cos\theta$. This reduction produces the cosine directivity characteristic.

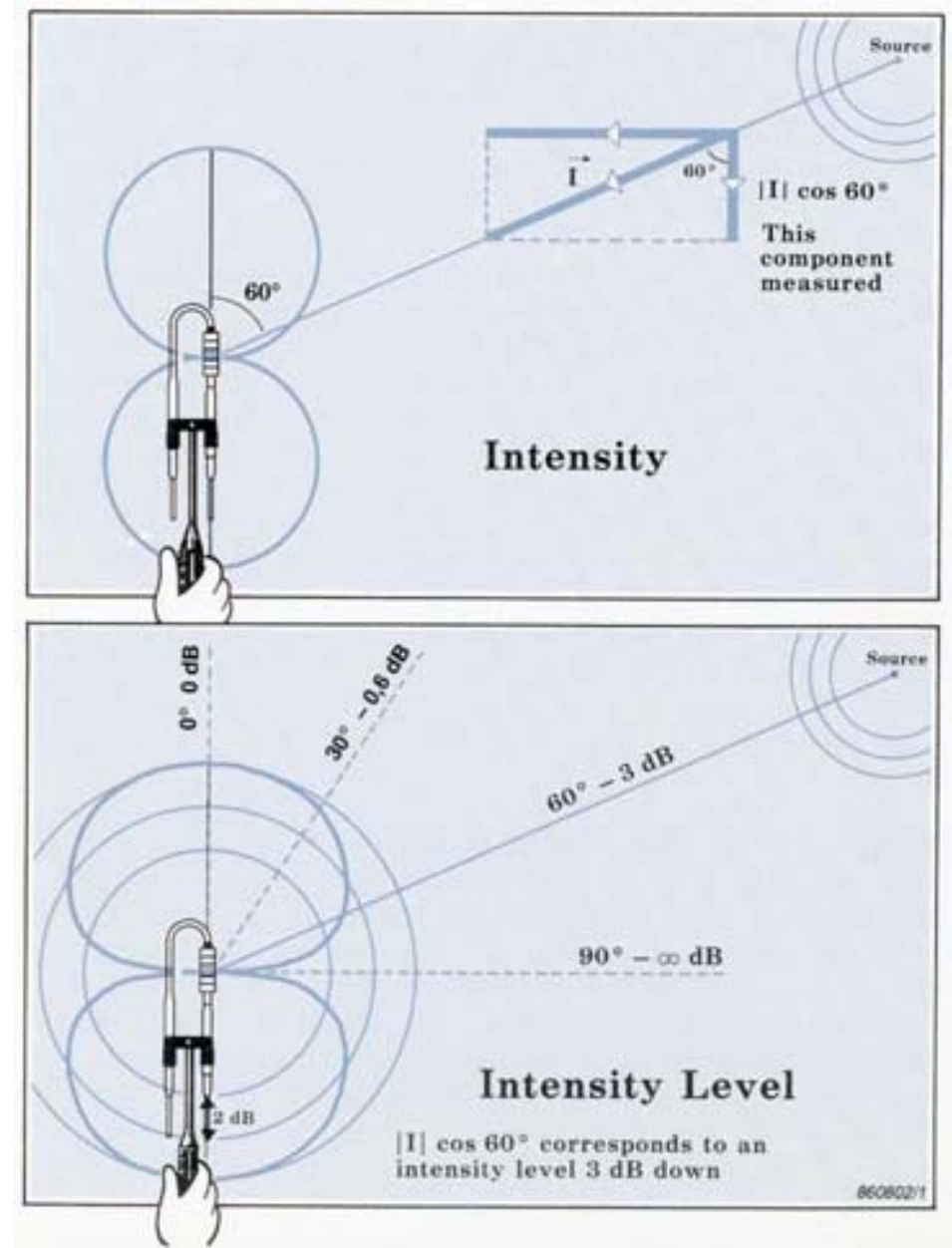

Reference Levels

The sound pressure, intensity, power and particle velocity levels, (L_p , L_i , L_w and L_u respectively), are all measured in dBs. Decibels are a ratio of the specified quantity measured against some reference. For pressure the reference level is chosen so that it corresponds approximately to the threshold of hearing.

Other reference levels have been approximately related to this by using the free field relations between pressure and intensity, and pressure and particle velocity. And in the free field we will obtain the same dB reading irrespective of whether we measure pressure, intensity or particle velocity (measured in the direction of propagation). Actually, because round numbers have been chosen for the reference levels, there is a slight difference in levels. The actual difference depends on the value of the characteristic impedance, ρc , of the medium in which it is measured. Here ρ is the density and c the speed of sound in the medium. The difference is usually negligible in air except at high altitudes. To avoid possible confusion with pressure levels, sound power levels are sometimes given in bels — 10 dB equals 1 bel.

In the free field the pressure and intensity levels in the direction of propagation are numerically the same. However, intensity measurements in the free field are not needed. In practice, we will not measure in a free field and so there will be a difference between the pressure and intensity levels. This difference is an important quantity known as the pressure-intensity index (previously known as the phase index or reactivity index with different sign).

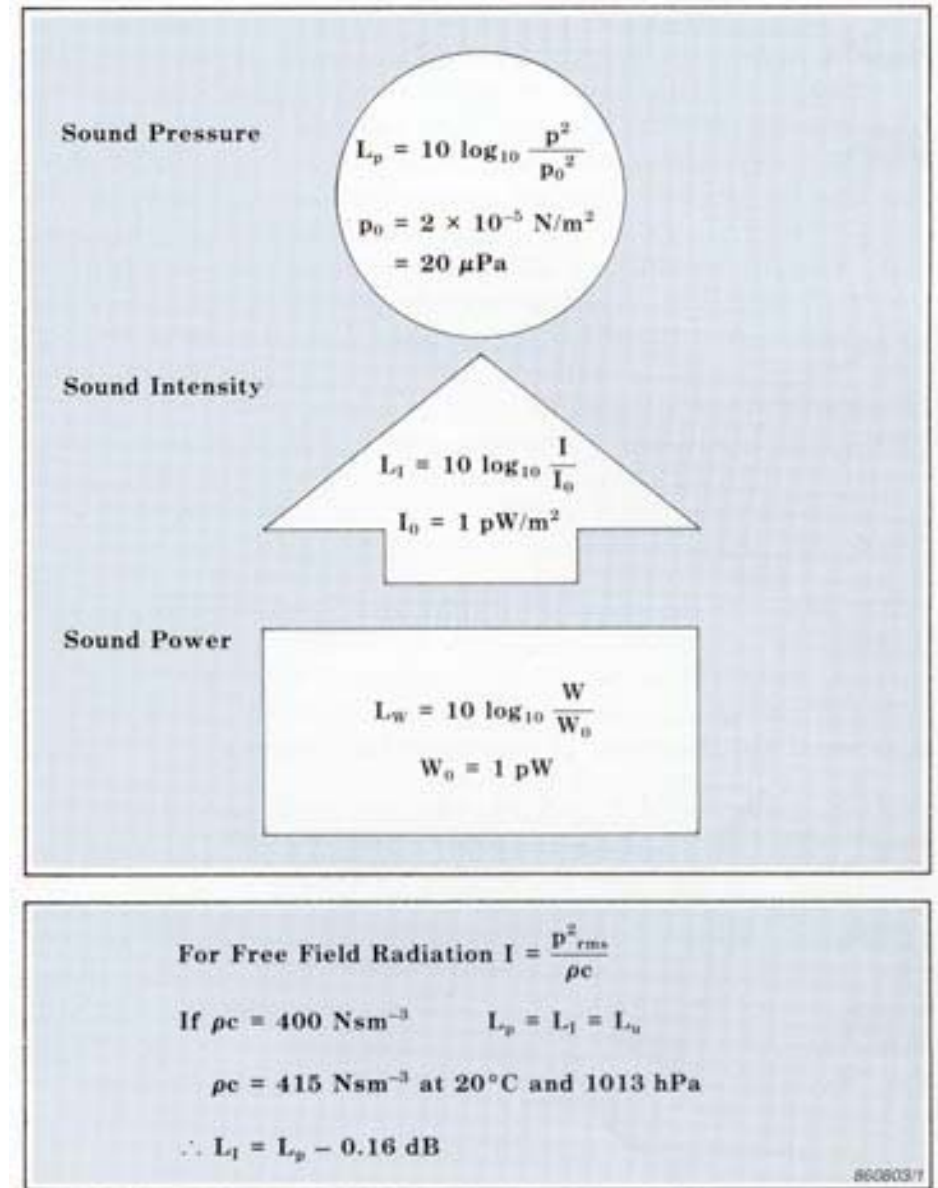

Some Examples

Working with the various reference levels and with dBs is often a source of confusion. Some examples are given to be of help.

1. A lawn mower radiates 0.01 watts acoustic power. What are the approximate sound pressure and intensity levels 1.5 m away? In the open air we can assume free field radiation and we will assume that the ground is perfectly reflecting. The power is radiated through hemispheres of surface area $27\pi^2$. At 1.5 m the surface area is about 14 m^2 . Therefore the intensity is $0.01/14 \text{ W/m}^2$ and the intensity level is 88.5 dB re 1 pW/m^2 . In the free field the pressure level will be approximately the same numerically: 88.5 dB re $20 \mu\text{Pa}$.

2. The question at the top of the board opposite highlights the confusion, especially with negative levels. Here the -80dB simply means that the intensity is so low that it is below the reference level. Hence the level (*not the direction*) is negative. Therefore the sum of the two levels will still be very close to 80 dB because the contribution of -80 dB is negligible. In fact, an intensity level as low as this will never be observed or measured in practice.

3. Now we have the case of adding intensity levels in different directions, a kind of vector sum. We want to find the intensity level when both people speak at once. Generally, we cannot simply add or subtract intensity levels; we have to convert back to intensity using $I = I_0 10^{L/10}$. However, knowing that 3dB represents a factor of two allows us to make a short cut. The negative-going intensity level is 3dB down on the positive-going intensity level and therefore half the intensity travels back to the first speaker. This corresponds to a 3dB drop in the positive-going intensity and so the answer is 67 dB.

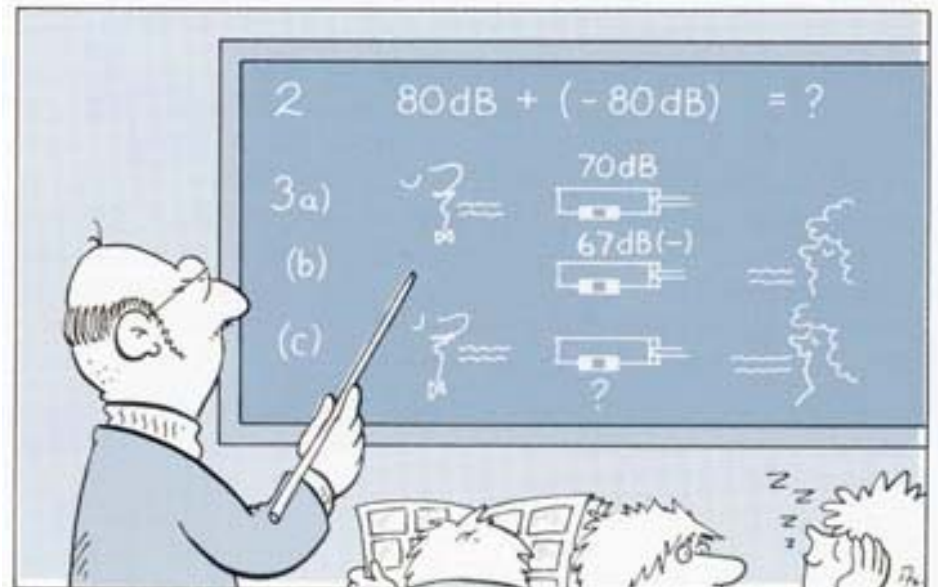
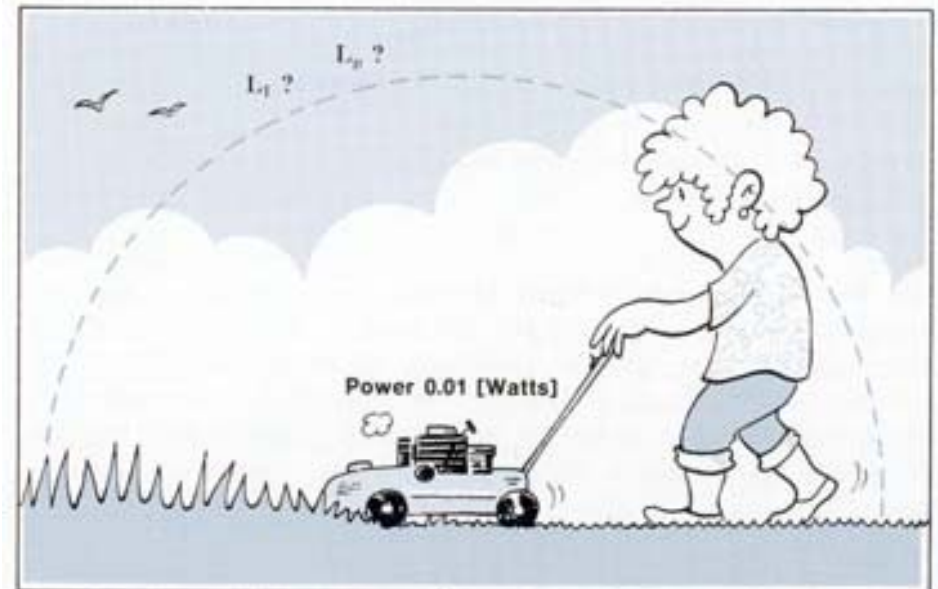

Using Sound Intensity to Determine Sound Power

The use of sound intensity rather than sound pressure to determine sound power means that measurements can be made in situ, with steady background noise and in the near field of machines. It is above all a simple technique. The sound power is the average normal intensity over a surface enclosing the source, multiplied by the surface area. First we need to define this hypothetical surface:

We can choose any enclosing surface as long as no other sources or sinks (absorbers of sound) are present within the surface. The floor is assumed to reflect all the power and so need not be included in the measuring surface. The surface may, in theory, be any distance from the source. Here are three examples:

First, the box. This can be any shape and size. This surface is easy to define and the planar surfaces make averaging the intensity over the surface a simple matter. The partial sound powers can be found from each side and added.

Second, the hemisphere. This shape is most likely to give the least number of measuring points. For an omnidirectional source in the free field the intensity will be constant over a hemisphere. International Standard ISO 3745 (sound power from pressure measurements) recommends starting with ten measurement positions; three microphone positions on three radii and one on the top of the hemisphere. If the intensity varies too much over this surface, the number of positions should be increased.

Third, the conformal shape. This allows near field measurements which will improve the signal-to-noise ratio. The measured intensity can also be related back to the specific source locations.

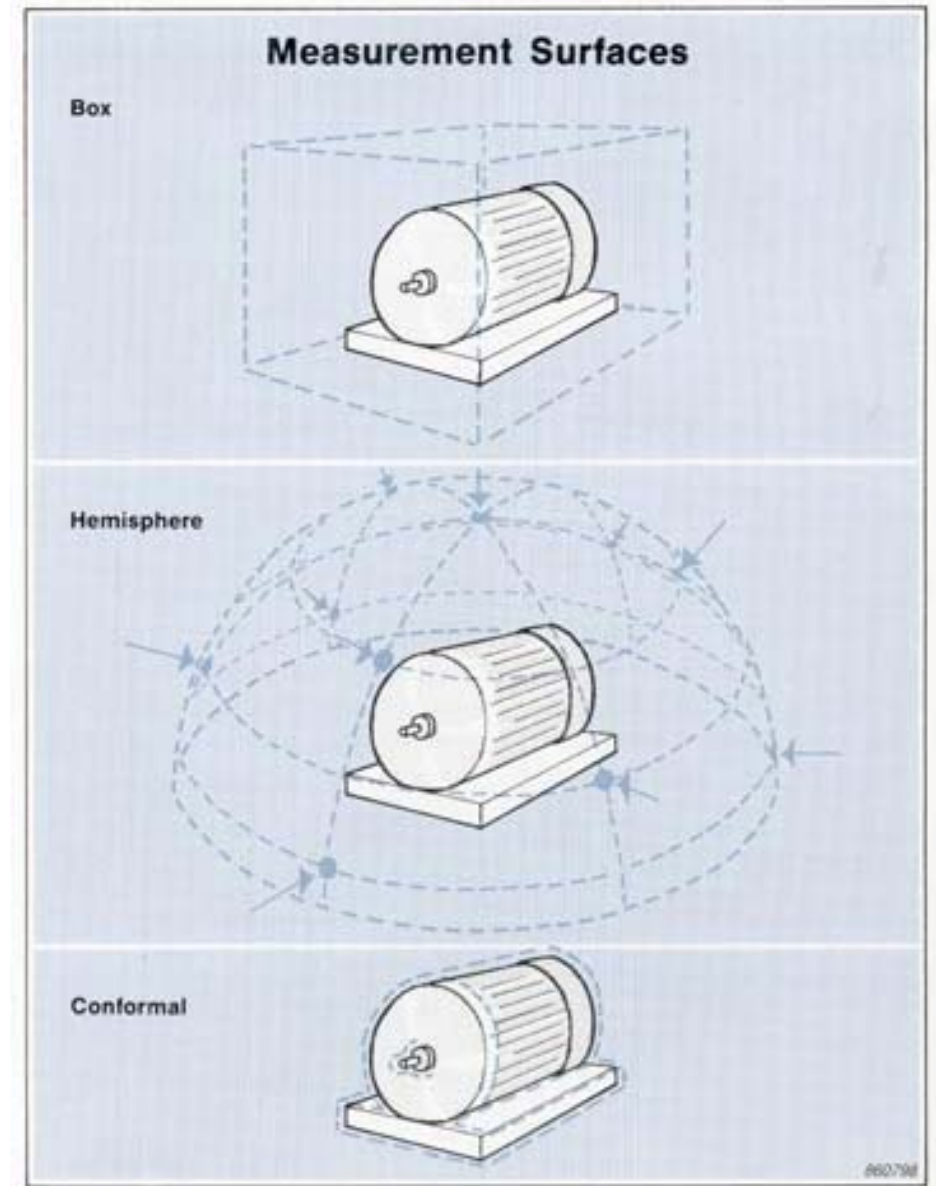

Spatial Averaging

After a surface has been defined, we need to spatially average the intensity values measured normal to the surface. Note that the surface can be defined with a physical grid or just as distances from reference points. To obtain an average intensity value from each side, one of two spatial averaging techniques can be used:

Swept measurements over the surface

With a suitably long averaging time, the probe is simply swept over the surface, as if the surface is being painted. This gives a single-value spatial average intensity. Multiplying by the area gives the sound power from this surface. Then the sound power contributions from all the surfaces are added.

Discrete Point Averaging

Another method of averaging is to divide up the side into small segments and measure the sound intensity in each segment. The measuring points are frequently defined by a grid. This can be a frame with string or wire although a ruler or tape measure can also be used. The results are averaged and multiplied by the surface area to find the sound power from the side.

Neither method is best for all applications and in some cases both methods may be useful. Because the swept technique is mathematically a better approximation to the continuous space integral, it is often more accurate. But care needs to be taken to sweep the probe at a constant rate and to cover the surface equally. The discrete point method, however, is often more repeatable. Both can easily be automated if repeated measurements have to be made. This also improves the accuracy.

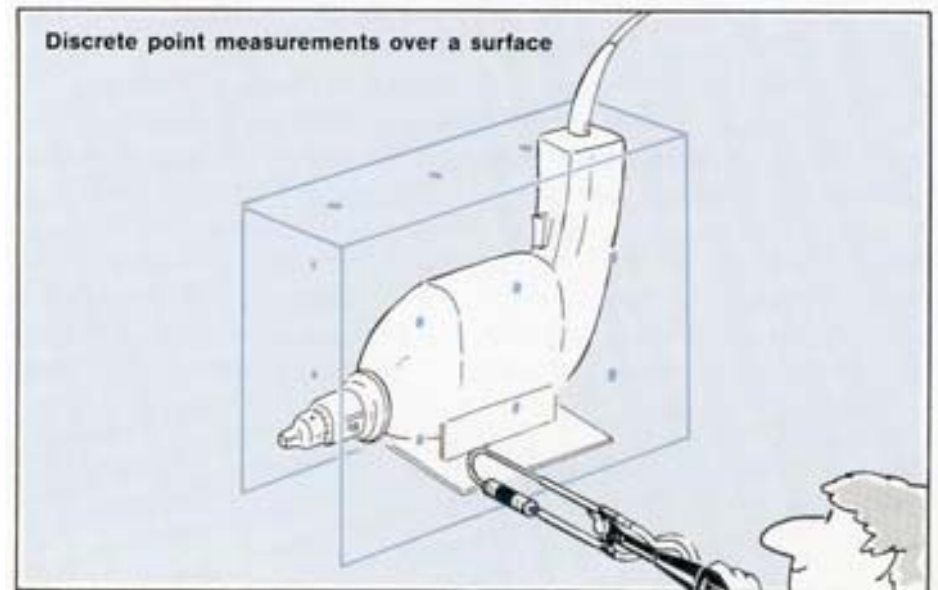
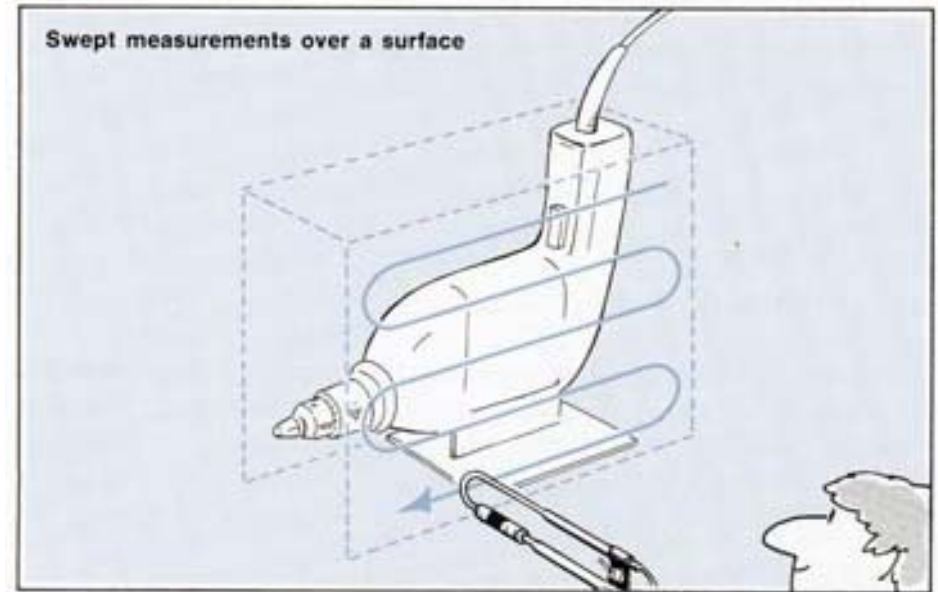

What about Background Noise?

One of the main advantages of the intensity method of sound power determination is that high levels of steady background noise are not important.

Let us imagine a surface in space — any closed volume will do. If a sound source is present within the closed surface then we can measure the average intensity over the surface of the box and multiply by the area to find the total sound power radiated by the source.

If the source were then moved outside the box and we tried to find the sound power we would measure zero. We will always measure some energy flowing in on a side. But the energy will flow out on other sides and so the contribution to the sound power radiated from the box will be zero.

For this to be true the background noise level must not vary significantly with time. If this condition is met the noise is said to be *stationary*. Note; with a long enough averaging time, small random fluctuations in level will not matter. A further condition is that there must be no absorption within the box. Otherwise some background noise will not flow out of the box again.

Background noise can be regarded as sources outside the measurement box and will have no effect on the measured sound power of the source. In practice this means that sound power can be measured to an accuracy of 1 dB from sources as much as 10 dB lower than the background noise. If background noise is a problem, then choosing a smaller measurement surface will improve the signal-to-noise ratio.

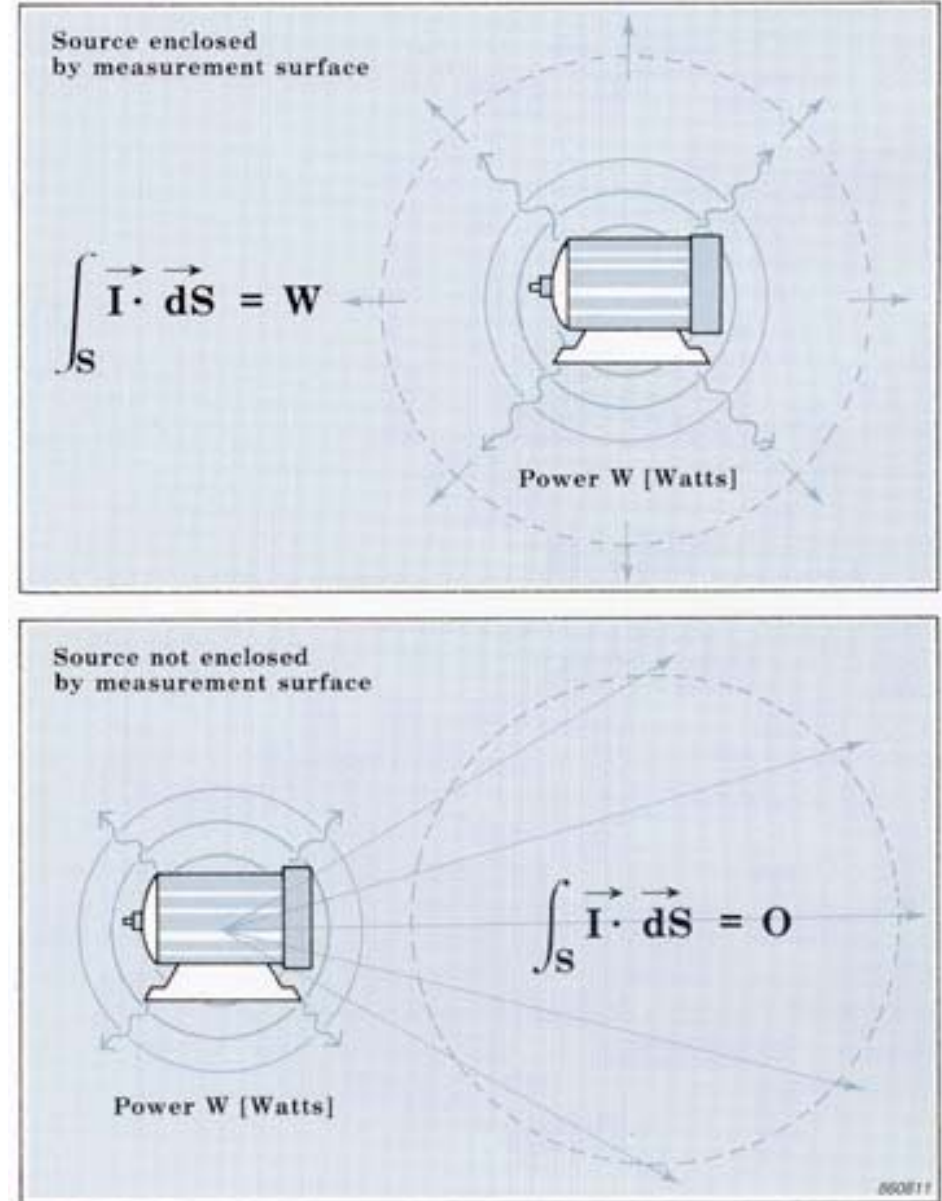

Noise Source Ranking

A complicated structure may radiate sound from several sources and absorb sound in other places. To evaluate the effectiveness of noise reduction methods we need to know how much noise is being radiated by the individual components of machines. This means finding the sound power from the components of a machine.

This is simple with sound intensity measurements because we can define a measurement surface which can enclose single components. All the other noise radiating components can be treated as background noise — provided the noise is stationary. Furthermore the total sound power can be found simply by adding the partial sound powers from all the noise radiating components. In the chain saw study shown opposite it was not possible to enclose all the individual sources. But the study still revealed that several surfaces were responsible for the noise. In order for there to be a significant reduction in the overall level, several components would have to be treated.

The intensity technique is straightforward. An investigation can be performed in situ, which is a great improvement on existing techniques. Previously, individual parts of a complex structure, a diesel engine for example, had to be isolated with soundproof enclosures. The pressure level from this component could be measured only if the machine were placed in an anechoic or reverberant room. This procedure often took several weeks.

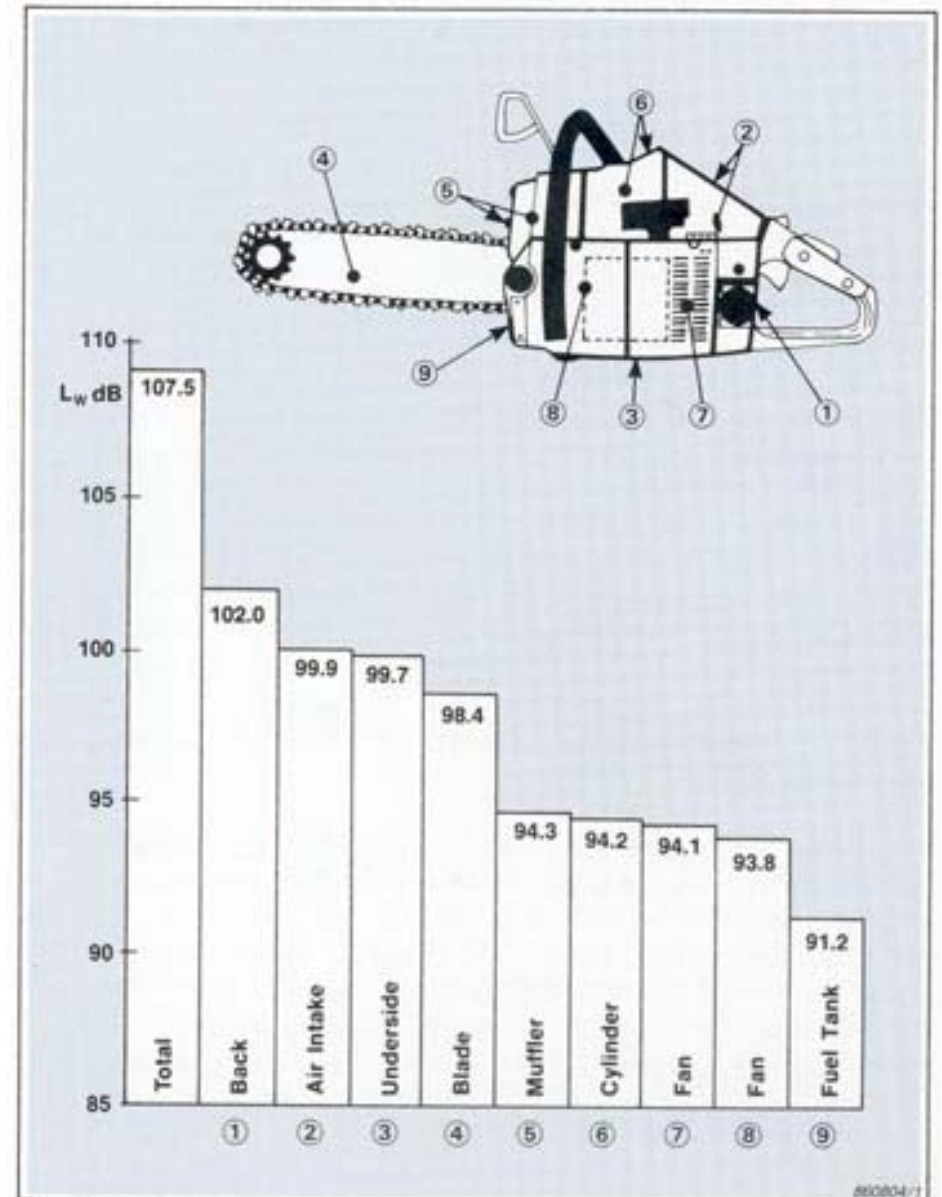

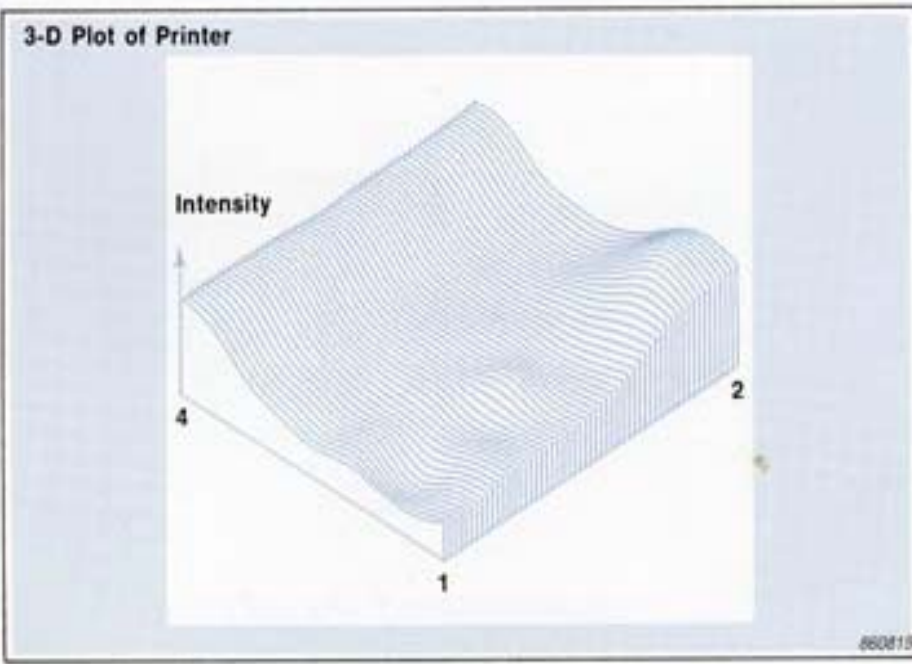
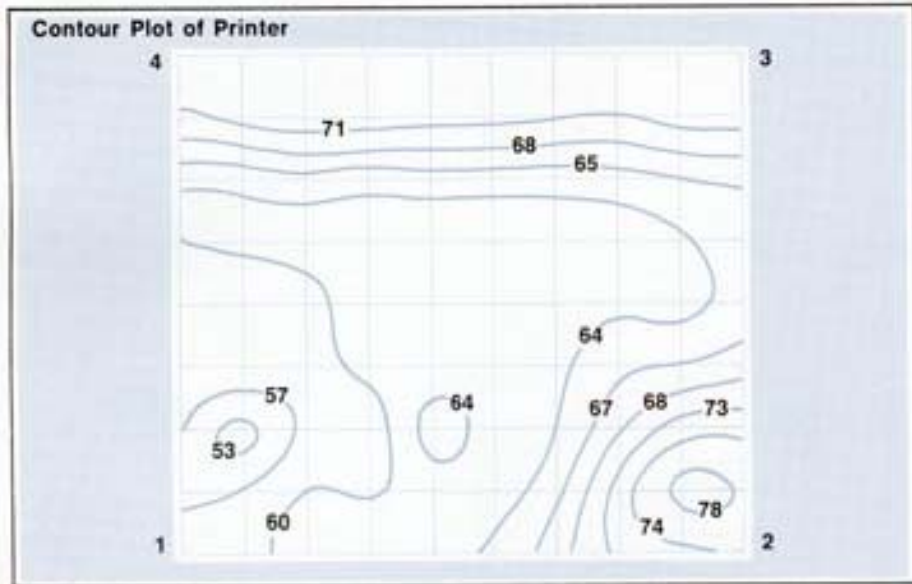

Source Location — the Null Search Method

As a quick and easy test we can make use of the probe's directional characteristic. Sound incident at 85° to the axis will be recorded as positive-going intensity, whereas sound at 95° will give negative-going intensity. Therefore there is a change in direction for only a small change in angle.

While we watch the display, the probe is swept so that its axis makes a line parallel to the plane on which we think the source is located. At some point, the direction will suddenly change. This position is identified where the display alternates rapidly between positive- and negative-going intensity. Here the sound must be incident on the probe at 90° to its axis and thus we have located the source. This method is useful when only one source is dominant — other sources or sinks may confuse the results.

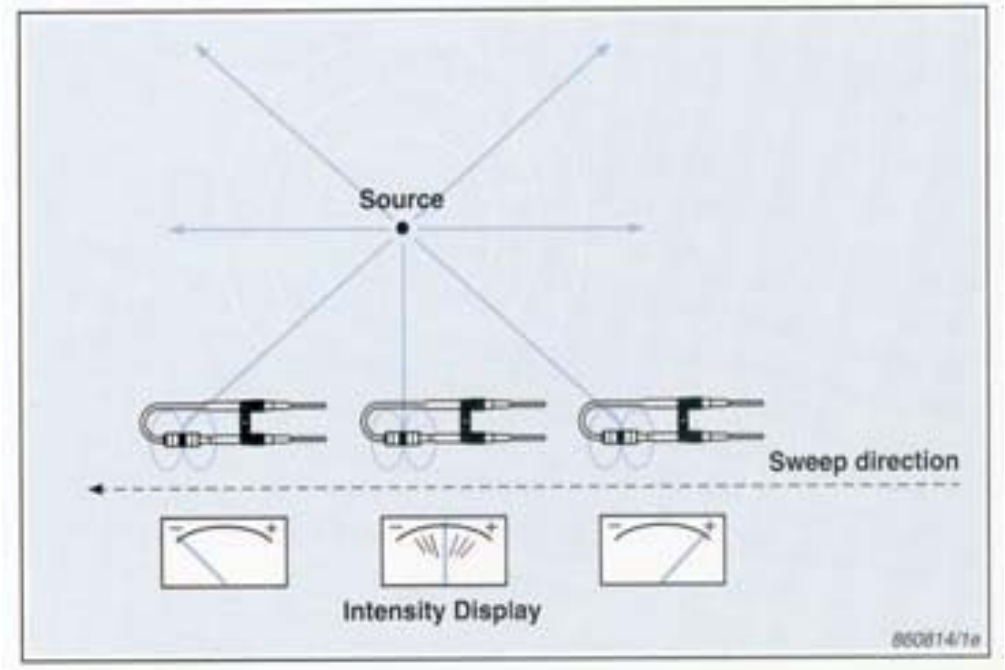

Applications in Building Acoustics

Measuring Airborne Sound Insulation

Sound intensity measurement has many applications in building acoustics; quantities such as noise reduction and acoustic absorption are fundamentally related to sound power. Therefore, intensity rather than pressure is the logical quantity to measure. For example, sound intensity measurements provide an alternative approach for measuring airborne sound insulation.

Measurements of the sound reduction index of a building element can be carried out in the laboratory or in situ, as shown in the diagram. In the source room the spatially averaged sound pressure level is calculated from sound pressure measurements. In the receiving room, a grid applied to the measurement surface defines the areas of interest. The average sound intensity flowing through each grid-segment can be measured directly by using a sound intensity analyzing system. The sound power emitted by each segment in the grid is simply the average sound intensity multiplied by the segment's area.

Since the flow of sound intensity through any surface in the room may be examined, it is possible to measure the contribution of the various flanking and leakage transmissions towards the total power in the receiving room.

A significant advantage of the intensity approach is that the apparent sound reduction index R'_n for any area on the measurement grid may be found. So if a compound partition is to be studied, for example a wall containing a window, R'_n may be found for both the wall material and the glass.

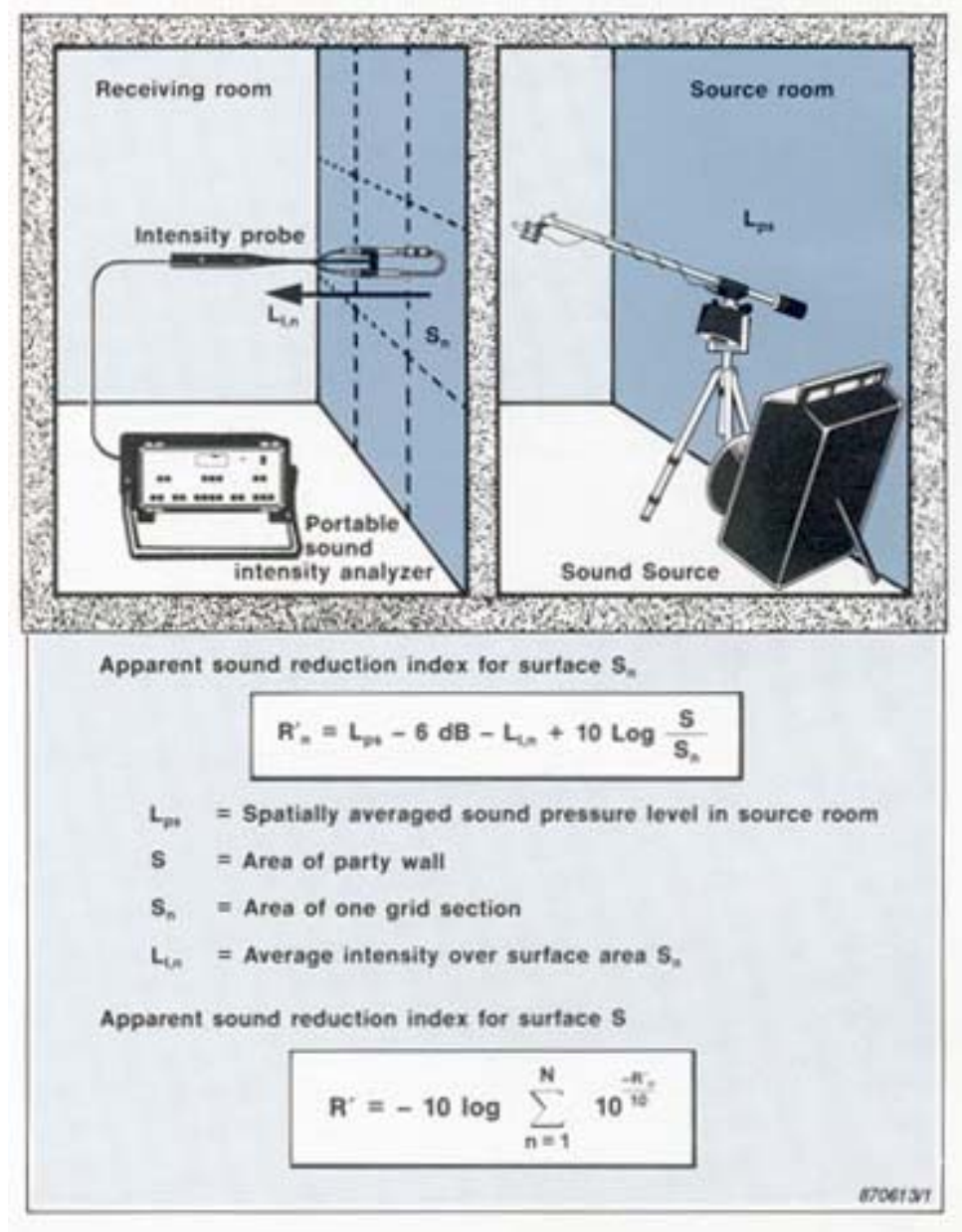

Instrumentation

There are three essential components in a sound intensity analyzing system: analyzer, probe and calibrator. Brüel&Kjær makes a complete range of these components, as well as providing postprocessing software packages, to give a choice of systems dedicated to intensity measurement.

The Analyzer

Brüel&Kjær produces many different intensity analyzers for laboratory and field use. Some examples are given here. The Type 2133 is a real-time analyzer with digital filters for parallel analysis of 1/1-, 1/3- and 1/12-octave bands. Dual channel analyzers such as Type 2032 use the Fast Fourier Transform to give the cross spectrum, and hence the intensity in narrow bands. For in-situ measurements, however, portable instruments are advantageous. Here the Type 4437 is an economical solution. It measures the intensity in 1/1-octave bands, is battery operated and is easily portable.

The Two-Microphone Probe

A number of Brüel&Kjær phase-matched probes are available for sound intensity measurements. For all the probes, remote control units allow the averaging to be controlled without the need to touch the analyzer.

The Sound Intensity Calibrator

Type 3541 generates known sound pressure, intensity and particle velocity levels in a small coupler. The calibrator is suitable for amplitude calibrations of the two microphone channels and for checking the values of intensity and particle velocity calculated by the analyzer. The calibrator can also be used to detect the residual intensity in the analyzing system and hence the pressure-residual intensity index which is a measure of the phase mismatch in the system (see Appendix).

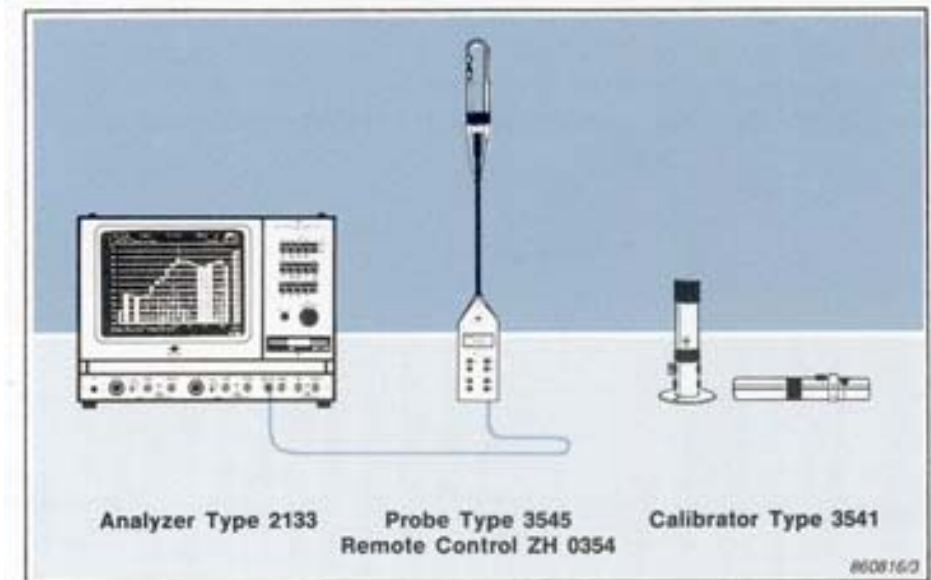
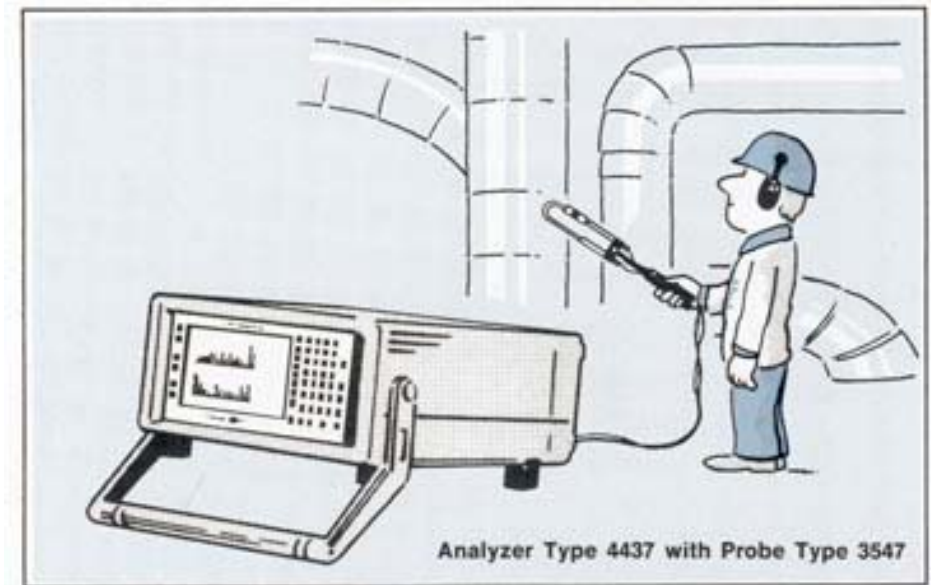

Making Measurements

There are, as yet, no standards for measurement of intensity and so we will now discuss several factors to be taken into account when making measurements.

Field Calibration

The two microphones are amplitude calibrated by applying a pistonphone to each microphone in turn, or to both microphones simultaneously by means of a coupler. Displayed intensity is checked against a known intensity level provided by a sound intensity calibrator. A correction accounts for changes in the density of air, but this is usually negligible except at high altitudes. The sound intensity calibrator can also be used to check the quality of phase-matching in the analyzing system by finding the pressure-intensity index and hence the dynamic capability of the system (page 33).

Time Averaging

To minimise the *random* error we require an averaging time long enough to give steady results. To judge the averaging time needed, several measurements can be taken and the averaging time increased until the results are repeatable.

Spatial Averaging

With swept measurements we must cover all areas equally. The sweep rate must therefore be constant and the area must be covered with a whole number of sweeps. With discrete point measurements the variability in the intensity over the measuring surface determines the number of points needed. If the variability is high the number of measuring points must be increased. It is easy to see when the spatial averaging is correct. Repeatable results for a number of different measurement surfaces, or for different measuring positions on the same surface, imply correct spatial averaging.

Background Noise

Providing the background noise is steady, measurements can be made to an accuracy of 1 dB even when the background level exceeds the source level by as much as 10 dB. If it is possible, measuring the sound power with the source turned off (background noise on) will give an idea of the contribution of the background noise. The effect of background noise is reduced by measuring closer to the source.

Choice of Spacer

We can choose between many lengths of spacer: 6, 8.5, 12 or 50 mm. The assumptions made in the theory impose an upper frequency limit on the intensity measurements — the *smaller the* spacer, the higher the frequency that can be measured. Phase mismatch in the analyzing system causes a low frequency limit — and the *larger the* spacer, the lower the frequency limit. This low frequency limit also depends on the ease of measurement in a general sound field, described by the *pressure-intensity index*.

The graph shown opposite can be used to determine the limits. To use it we need to measure the pressure-intensity Index which describes the sound field. The pressure-intensity Index is simply the pressure level minus the intensity level. The other factor determining the low frequency limit is the phase mismatch in the analyzing system. A conservative estimate for Brüel&Kjær instrumentation is $\pm 0.3^\circ$. Let us find the limits in a field where the pressure-intensity index is - 3dB. Looking at the bar for a 12mm spacer we see that the limit is about 250 Hz. To measure a lower frequency we need a 50 mm spacer. With this we can measure down to 63 Hz. However, with this spacer the high frequency limit is only 1.25 kHz. And so no single spacer can cover a wide frequency range.

Total Phase Mismatch in Probe and Analyzer

Pressure-Intensity Index

$$L_p - L_i$$

0 dB
3 dB
10 dB

0 dB
3 dB
10 dB

0 dB
3 dB
10 dB

0 dB
3 dB
10 dB

0 dB
3 dB
10 dB

0.1°

0.2°

0.3°

Microphone Spacing, Δr

6 mm



1/4-inch

12 mm



1/4-inch

8.5 mm



1/2-inch

12 mm



1/2-inch

50 mm



1/2-inch

10 20 40 63 80 125 200 400 800 1.25k 2.5k 5k 10k

Frequency [Hz]

Frequency Ranges for a measurement accuracy of 1dB as a function of Pressure-Intensity Index, Microphone Spacing and Phase Mismatch

800817/0e

Further Applications and Advanced Topics

So far only the most common applications of intensity measurement have been described. Many other applications are under investigation and development.

Gated Spectrum Analysis

We often want to study the noise signals from rotating and reciprocating machinery, in particular one part of the signal. By measuring the signal for a certain interval of the cycle only (gating), and then repeating the process for many cycles, enough averages are taken to make the signal appear stationary. To measure only one interval of a cycle the intensity measurement is usually triggered by a reflecting strip on one part of the rotating machinery which is sensed by a photoelectric probe. The trigger pulse then starts or stops the analysis for a fixed amount of time. In this way it is possible to study one part of a cycle only, for example the initiation of combustion in an engine, or a particular event in a production process. Gated analysis can be used with both pressure and intensity measurements. With intensity, however, we can use the results for source location and make gated contour plots, etc.

Radiation Efficiency

A surface radiates energy by transmitting the vibrations of the surface to the air. The efficiency with which it does this is called the radiation efficiency. Knowledge of this is useful for development work and allows the sound power of the surface to be predicted. Radiation efficiency is defined as the intensity produced divided by the intensity that would be radiated by a piston moving at the same velocity as the surface of interest. The intensity produced can be measured with the two-microphone probe and the velocity of the surface can be measured with an accelerometer.

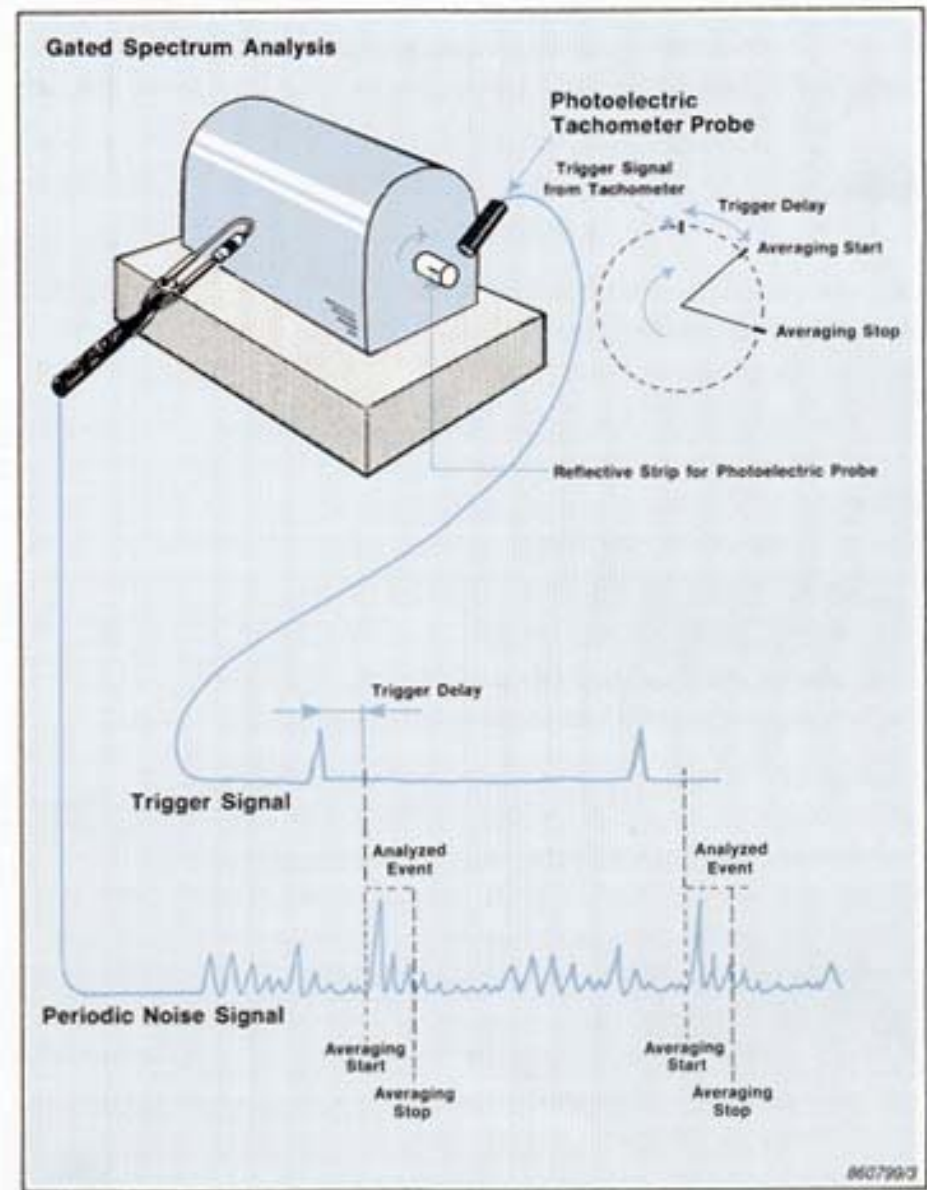

Full Vector Intensity Measurement

Intensity is a vector quantity. Usually only the component in the axial direction is measured. However, it is possible, by using three mutually perpendicular microphone pairs, to measure all three components at once and then to calculate the vector with a computer.

Structural Intensity

With two microphones we can find the intensity in air. Similarly it is possible to measure the structural intensity through a solid plate with two closely spaced accelerometers. The technique is used for determining the power flow through large noise-radiating structures.

Intensity in Ducts

It has long been of interest to study the energy flow in ducts, such as air-conditioning systems. Now the complicated intensity distributions in ducts can be studied and the sound power found. For ducts with flow, a windscreen must be placed over the microphones to reduce flow noise. Measurements cannot be made in very high speed flows.

Spatial Transformation of Sound Fields (STSF)

By correlating pressure measurements close to a machine with measurements at reference points it is possible to obtain a detailed picture of the sound field at the measurement plane and at other specified planes. In this way the pressure and intensity can be predicted far away from the source. This is of importance to the motor industry where standards give limits for noise levels far from the source. By using this technique the noise level far from the source can be predicted at the developmental stage based on measurements close to the source.

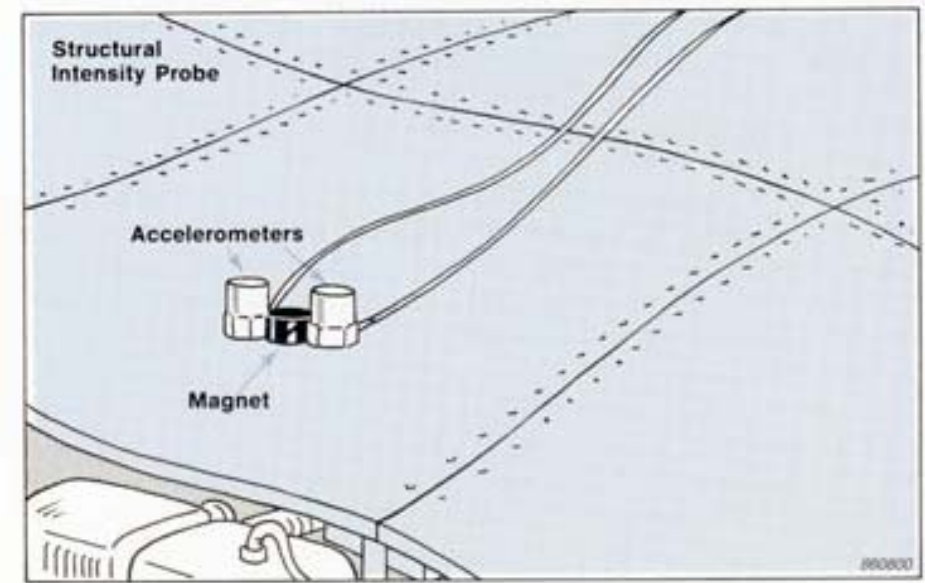
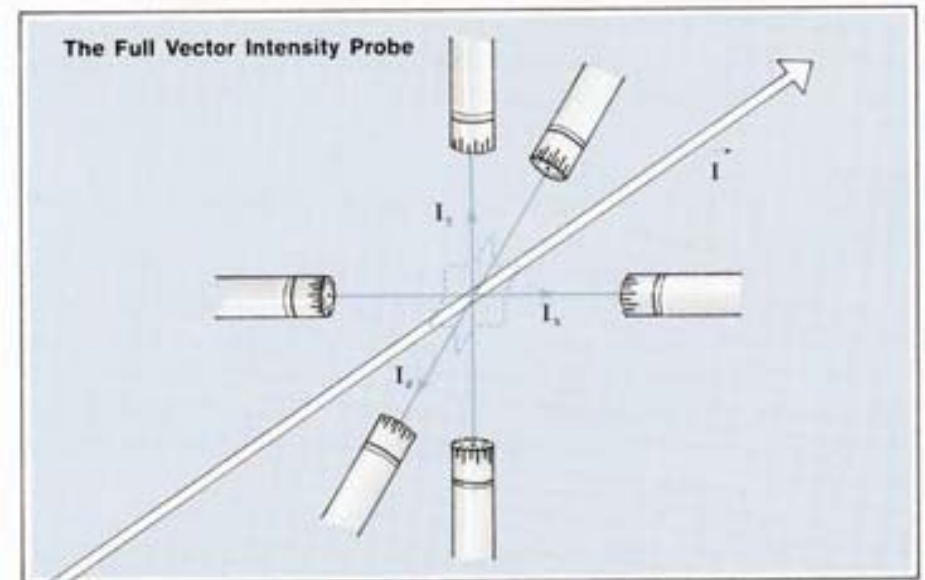

Case Studies

To illustrate the importance and usefulness of the sound intensity method two actual applications follow where intensity measurements gave clear and quick answers to real-life problems.

1. Effective Noise Control on a Coupled Pump and Motor Assembly

A pump and motor assembly was producing too much noise. The pump and motor noise was measured in a reverberation room in order to determine the sound power from pressure measurements. At 88.4 dB this was unacceptable. The motor was uncoupled and measured alone; the sound power was only 65 dB. Therefore the problem seemed to be the pump.

But clearly these measurements were not made under operating conditions. With pressure measurements, the only way to measure the pump separately under load would have been by enclosing the motor in a soundproof box. This would have been impractical and since no box is completely soundproof it would also have been inaccurate. However, with intensity measurements we can distinguish between the pump and motor in situ. Since the assembly was already in the reverberant room it was left there. Time could, however, have been saved by performing measurements in situ since sound intensity measurements do not require controlled sound fields.

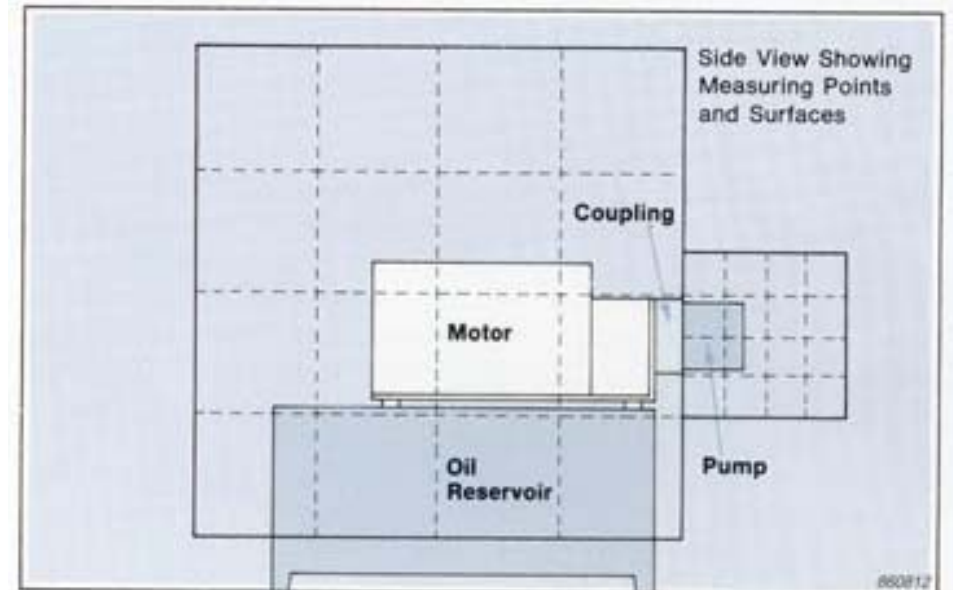
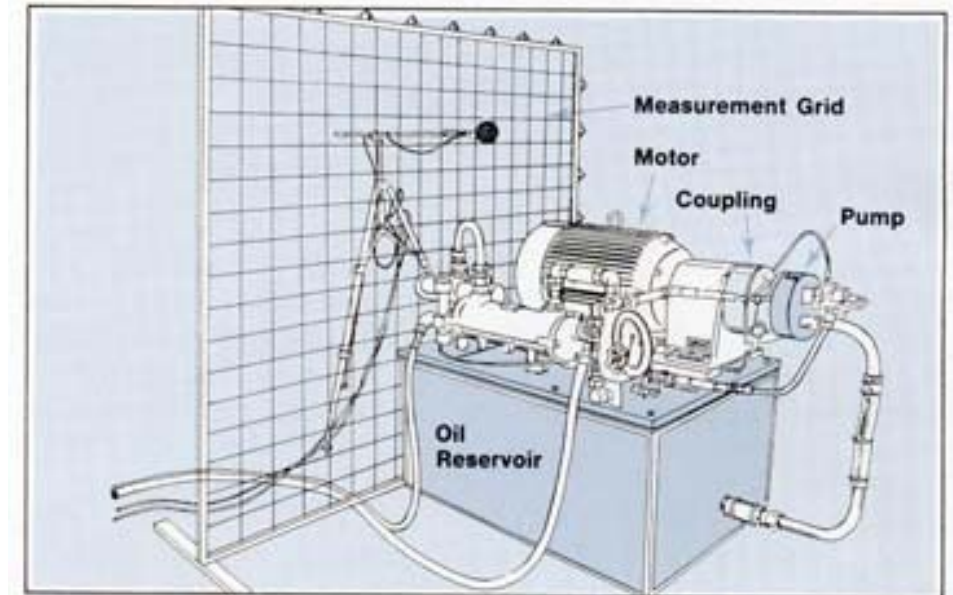

The first step in determining the sound power was to define the measurement areas. Two boxes were defined with rectangular frames and a grid of string locating the measurement points. The smaller box enclosed the pump and a larger box enclosed the motor and its oil reservoir. The boxes fitted closely around the assembly to improve the signal-to-noise ratio. In this case the "noise" consisted of the reflections from the walls of the room.

The sound power of each box was measured and it was found that that the motor radiated more noise than the pump — the level from the motor was 86.7 dB and the level from the pump was 83.5 dB. These results could not be found from pressure measurements without the previously mentioned soundproof enclosures.

The reason for the high level from the motor was that it was radiating vibrational energy transferred through the coupling from the pump. The motor and its oil reservoir had large surface areas which were extremely efficient at radiating noise. To reduce the noise the oil reservoir was removed. This conclusion could have been made with experience, but sound intensity measurements give the noise control engineer clear experimental evidence.

Note that although these measurements took place in a diffuse field where there was a large difference between pressure and intensity (pressure-intensity index), the measurements were still valid.

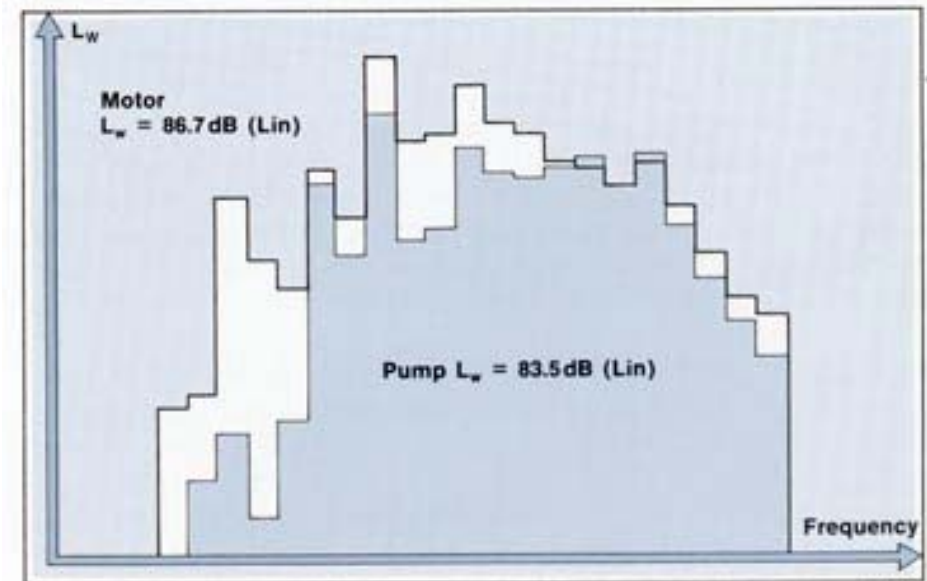
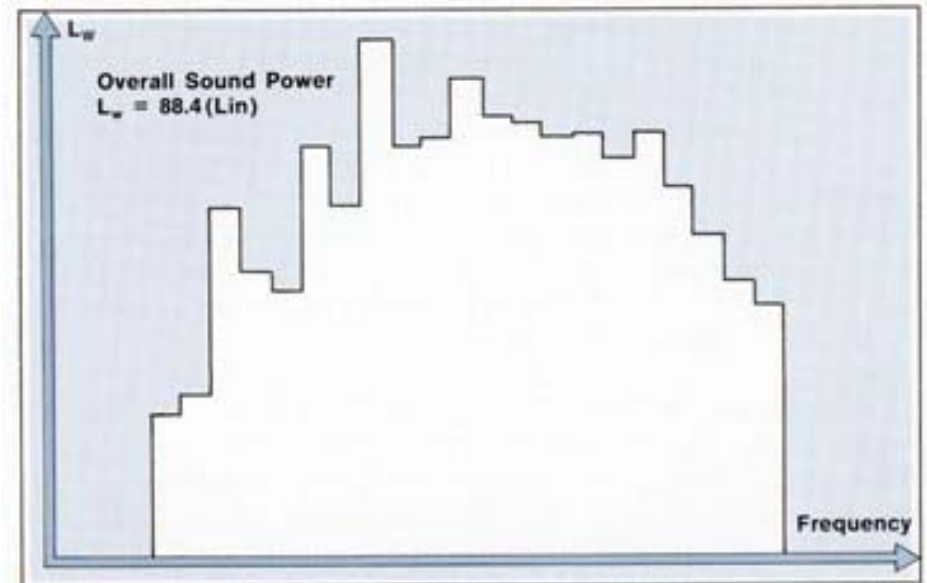

Case Study Two: Measurement of Wall Transmission Paths

Sound can enter buildings in many ways, not only through the walls. Sound may also be transmitted through structure-borne paths and air-conditioning ducts. Walls may be constructed of different materials and have windows and doors which have acoustic leaks. Thus, although we can place a sound source in an adjacent room and, with spatially averaged pressure measurements, calculate the sound transmitted, we cannot necessarily find out how it is being transmitted into the room. Furthermore the presence of standing waves can confuse the results.

By making sound intensity measurements we can measure sound power transmitted through small sections of a wall. We can also locate the sources of sound from the wall by making contour plots. Another technique is to scan the sound intensity probe over the surface of a wall and use the null search method (page 19) to locate sources of sound from leakage paths.

A short study was made in a row of terraced houses. A sound source was placed in one room and in an adjacent room the sound power was measured over segments of a wall. In order to make valid measurements some absorbent material was placed in the room. This made the room less reverberant; the reverberation time was reduced to about half a second.

The results were surprising. The highest levels were measured at the extreme left hand part of the wall (referring to the figure opposite). The part which faced the outside, and not the adjoining room. An outside pressure measurement excluded airborne transmission from the outside. And therefore the high levels must be caused by flanking transmission via a structural path.

Different materials were used in the wall's construction. The left hand side of the wall was made of breezeblock (cinder block) whereas the rest was concrete. The breezeblock radiated more sound because it was lighter. But this was not immediately obvious and could not have been found simply by making pressure measurements.

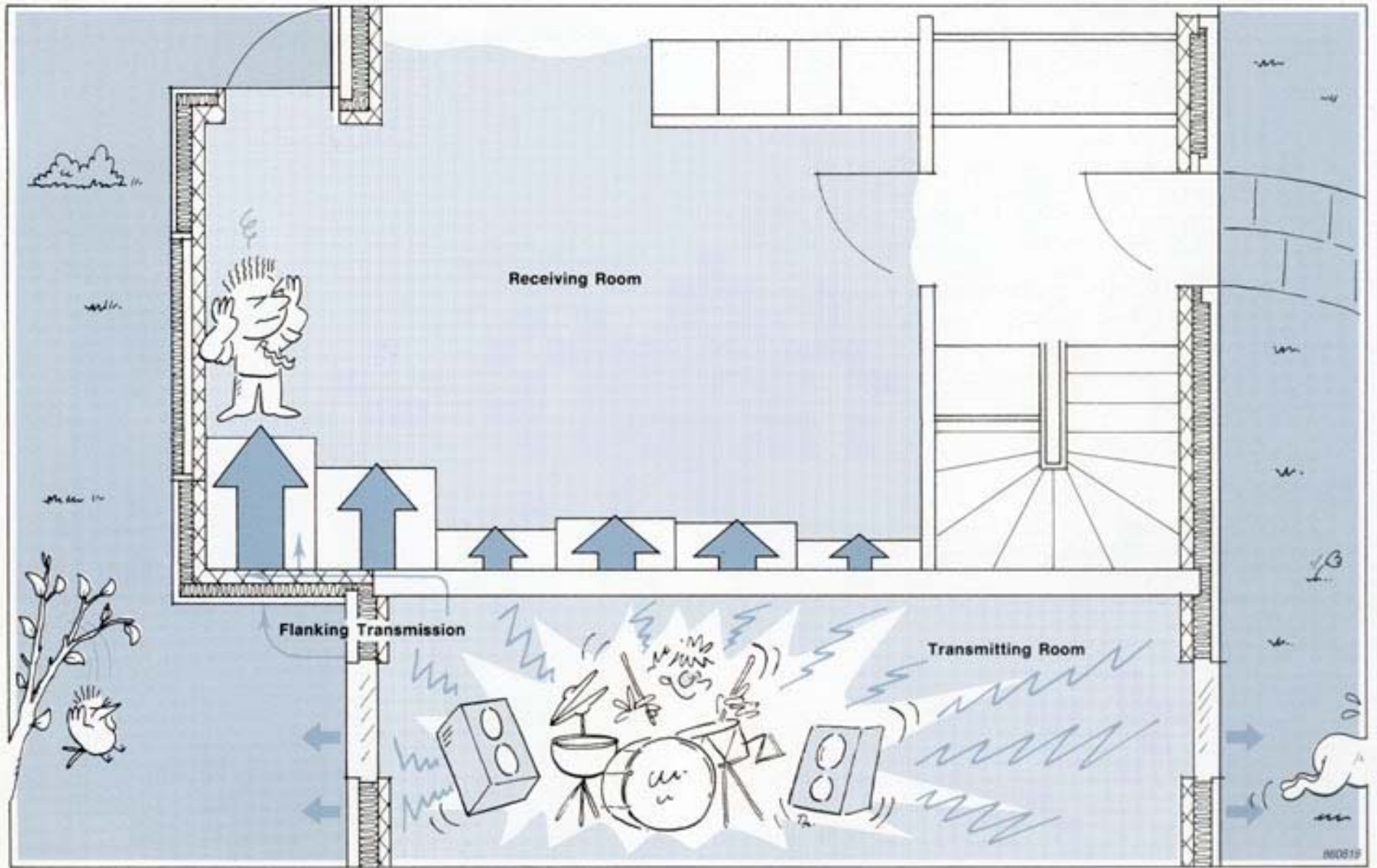

The Low Frequency Limit: Phase Mismatch Errors

The amount of phase mismatch between the two channels in the analyzing system determines the low frequency limit. Earlier in this booklet, the term phase was used to describe the shift between pressure and particle velocity. Here it is used to describe the shift in a wave with *time* or *distance*. One wavelength can be expressed in terms of a rotation of 360° . The distance between the two microphones can be expressed as a fraction of a wavelength or equivalently as a change of phase between the two points. Intensity is directly related to this phase change; without a phase change there is no propagation and therefore no intensity.

This phase shift is also equivalent to the time taken for the wave to propagate over the spacer distance. The time separation must be preserved to measure the correct intensity. However, in all analyzing systems there will be a small time delay between the two channels which introduces a small phase change. This is called a *phase mismatch* error. For a good probe and analyzer combination an outside estimate might be $\pm 0.3^\circ$. The phase mismatch error is a *bias* error and the intensity is under- or overestimated according to the sign of the phase mismatch. For accuracy to within 1 dB the phase change over the spacer distance should be more than five times the phase mismatch.

To obtain negligible high frequency error the wavelength must be six times the spacer distance. Then the spacer corresponds to one sixth of a wavelength and so the change in phase across the spacer distance is 60° . Obviously a phase error of $\pm 0.3^\circ$ will be insignificant. Now let us try to measure a lower frequency: At 63 Hz the wavelength is approximately 5.5 metres and the change of phase over a 12mm spacer is only 0.8° . So a phase mismatch of $\pm 0.3^\circ$ will cause a significant error in the intensity.

Now let us try a larger spacer. With a 50 mm (approximately four times 12 mm) spacer the phase change is 3.3° (approximately four times 0.8°) and so our results will be sufficiently accurate. This is why a large spacer is needed for low frequencies.

These examples are only valid for free field propagation along the probe axis. In general, the phase change will be reduced with angle of incidence and in a reactive or diffuse field. Fortunately it is not simply a matter of guess work to determine the phase change. Read on!

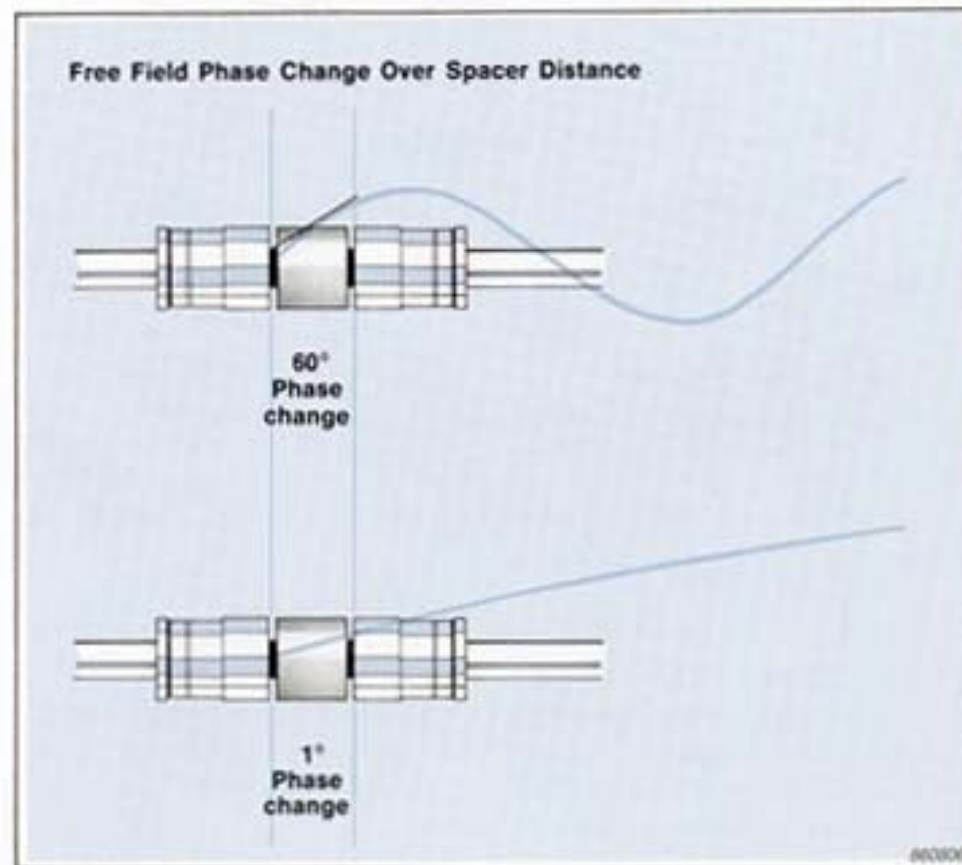

Pressure-Intensity Index and Phase

If sound is incident at an angle to the probe axis, the phase change to be detected is smaller. In other words the effective spacer distance is reduced. The decrease in the phase change causes the measured intensity to be reduced by the $\cos\theta$ factor. But the pressure, a scalar quantity, is the same whatever the angle of incidence. Hence there is a difference between the intensity and pressure levels. And the phase mismatch error will become more significant and the measurement frequency range will be reduced.

The difference between pressure and intensity also occurs in reactive and diffuse fields, as the intensity can be low even when the pressure is high. The name for this difference is the *pressure-Intensity index*.

The pressure-intensity index is a very important indicator to the accuracy of a measurement. This is because it can be related to the phase change across the spacer. By measuring the pressure-intensity index we can determine phase change across the spacer, and find out if the phase mismatch will make the measurement inaccurate. The phase change in degrees is calculated with the formula shown opposite. With this formula we can determine whether the phase mismatch error will be significant compared to the phase change over the spacer.

In a general sound field, the phase change varies from point to point and so the pressure-intensity index should, strictly speaking, be measured at each measurement point. However, an average *global* value, the space-average pressure level minus intensity level, is often sufficient to give an idea of the accuracy.

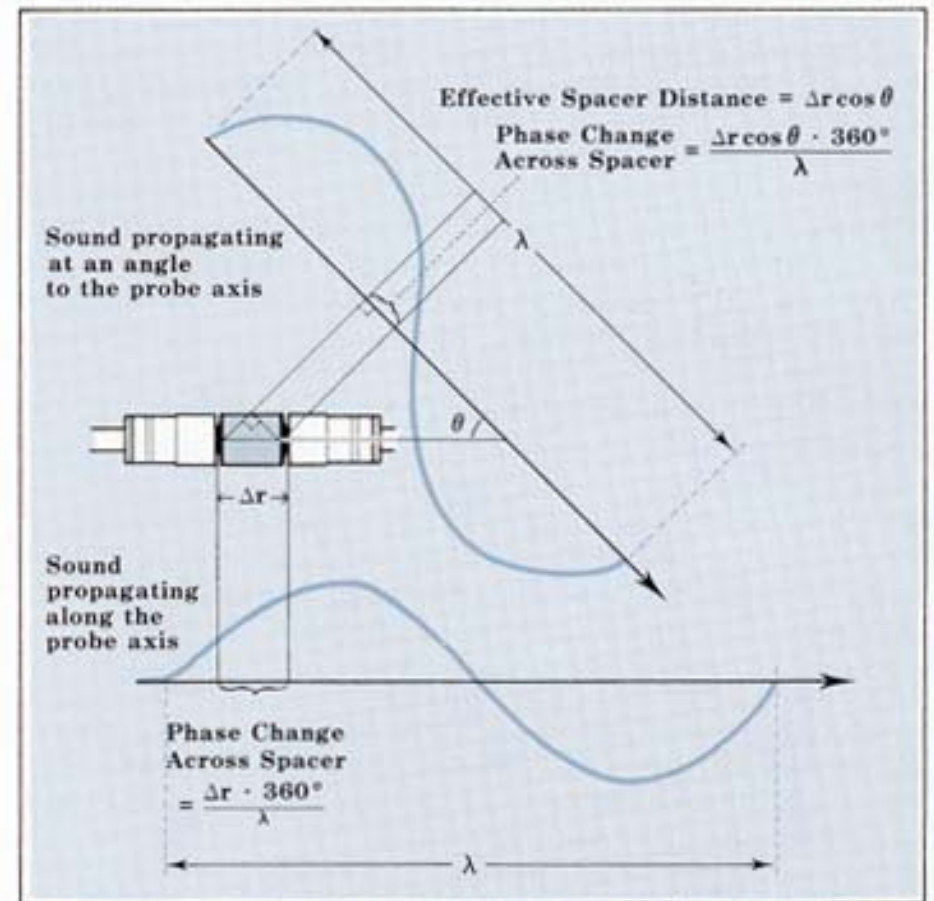

$$10 \log_{10} \left(\frac{pc}{400} \right) = 10 \log_{10} \left(\frac{\lambda}{\Delta r} \cdot \frac{\phi}{360^\circ} \right) + L_p - L_i$$

$L_p - L_i$ is the measured pressure-intensity index

ϕ is the phase change over the spacer distance Δr

$10 \log_{10} \left(\frac{pc}{400} \right)$ is a small correction term usually negligible.

Proc. Symposium on Acoustic Intensity, Tokyo, Japan. (1987).

Proc. 2nd Symposium on Acoustic Intensity, Tokyo, Japan. (1988).

Proc. 3rd International Congress on Intensity Techniques, CETIM, Senlis, France. (1990).

Many other papers on sound intensity measurement are also to be found in the **INTER-NOISE** proceedings from 1978 onwards.

Measurement Accuracy

S. GADE.

"The Validity of Intensity Measurements in Partially Diffuse Sound Field." *Brüel & Kjør Technical Review* 4, 3-31 (1985).

A. F. SEYBERT.

"Statistical Errors in Acoustic Intensity Measurements." *J. Sound Vib.* 75, 519-526 (1981).

P. S. WATKINSON.

"The Practical Assessment of Errors in Sound Intensity Measurement." *J. Sound Vib.* 105, 255-263 (1986).

ISO Standards.

ISO/DIS 9614 (Part 1).

"Determination of Sound Power Levels of Noise Sources using Sound Intensity-Part 1: Measurement at Discrete Points."

ISO 3740 - 3746.

"Determination of Sound Power Levels of Noise Sources." (Pressure Measurements). See also ANSI S.1 31 - 36.

We hope this booklet has answered many of your questions and will continue to serve as a handy reference. If you have other questions about sound intensity measuring techniques or instrumentation, please contact one of our local representatives or write directly to:

**Brüel & Kjør
2850 Nærum
Denmark**

Brüel & Kjær

WORLD HEADQUARTERS: DK-2850 Nærum · Denmark · Telephone: +45 42 80 05 00 · Telex: 37316 bruka dk · Fax: +45 42 80 14 05

Australia (02) 450-2066 · Austria 0222/816 74 00 · Belgium 02-242 97 45 · Brazil (011) 246-8149/246-8166 · Canada (514) 695-8225 · Czech Republic 02-24310458
Finland (0) 1481577 · France (1) 64 57 20 10 · Germany 04106/70 95-0 · Great Britain (081) 954-2366 · Holland 03402-39994 · Hong Kong 548 7486 · Hungary (1) 215 83 05
Italy (02) 57 60 41 41 · Japan 03-5420-7302 · Republic of Korea (02) 554-0605 · Norway 66 90 44 10 · Poland (0-22) 40 93 92 · Portugal (1) 65 92 56/65 92 80
Singapore 225 8533 · Slovak Republic 07-55666 · Spain (91) 368 10 00 · Sweden (08) 71127 30 · Switzerland (1) 862 19 60 · Taiwan (02) 713 9303 · Tunisia (01) 232 478
USA: MA (508) 481-7737 GA (404) 981-6225 MI (313) 522-8600 IL (708) 358-7582 CA (800) 442-1030 WA (206) 883-2203/882-4359

Local representatives and service organisations world-wide